



## Heavy Duty Ag Lights



TLA2701  
TLA2716

- Dual lights provide running lights and turn signals
- Meets ASABE S279.13 including 4cp to side on amber lens
- Mounting: vertical, horizontal or inverted horizontal
- Vertical or inverted horizontal mounting require reversing RH & LH
- Light with 4-pin plug also provide brake lights

TLA2700	LED 3-pin plug, left hand	\$85.95
TLA2701	LED 3-pin plug, right hand	\$85.95
TLA2715	LED 4-pin plug, left hand w/ brake light	\$85.95
TLA2716	LED 4-pin plug right hand w/ brake light	\$85.95

## Heavy Duty Ag Light Kits



TLA2770

TLA2776

- Provides turn signals and running lights
- Mounting: Vertical, horizontal or inverted horizontal
- Vertical or inverted horizontal mounting require reversing RH & LH
- TLA2770- Includes LED TLA2700 & TLA2701, 35' wishbone wire harness, 5' convoluted tubing, 7HD plug & tri-plugs to plug into lights
- TLA2776- Includes LED TLA2715 & TLA2716, 46' round wishbone cable, 7HD plug & quad-plugs to plug into lights, and 4- 90 lb pull magnets. Provides brake lights. Can be permanently mounted.

TLA2770	LED economy light kit	\$252.00
TLA2776	LED deluxe light kit with magnets	\$352.95

## Single LED Ag Light



TLA2722

- Amber front and back
- Mounting: vertical, horizontal or inverted horizontal

TLA2722	Single LED Ag Light 2 pin plug, Amber	\$60.95
---------	---------------------------------------	---------

## Pedestal Lights



TLS050

TLS150

- Pedestal mount
- Commonly used on tractor fenders
- TLS050-Chrome die cast housing.

TLA050	RED/AMBER LED 4" Round Pedestal light	\$44.95
TLA150	RED/AMBER Incandescent 4" Round	\$7.39

## Rectangle LED Work Lights



TLW481

TLW482

TLW684

TLW682

- Rugged aluminum housing with stainless bracket and bolt
- TLW481- 18W, 18" wire leads, 90° flood, 3 yr warranty
- TLW482- 18W, 36" wire leads, 5 yr warranty
- TLW684- 27W, 18" wire leads, 3 yr warranty
- TLW682- 40W, 28" lead with Deutsch connectors, 5 yr warranty

TLW481	6½"x1¼"	6 LED	10-30V	1,320 lumens	\$38.95
TLW482	6"x5"	6 LED	12-24V	1,350 lumens	\$48.95
TLW684	4¼"x4¼"	9 LED	10-30V	1,900 lumens	\$45.95
TLW682	3" x 3"	4 LED	12V	3,039 lumens	\$57.95

## Round LED Work Lights



TLW080

TLW084

- 3 year warranty
- TLW080- Rugged aluminum housing, 12-24 V
- TLW084- Stainless bracket, Rugged aluminum housing, 10-30 V

TLW080	4½" round, rugged 6 LED, 1350 lumens	\$36.95
TLW084	4½" round, rugged 9 LED, 1900 lumens	\$49.95

## Halogen Work Lights



TLA180

TLA580

- TLA180- 5/16" mounting bolt with 6" wires
- TLA580- 1/2" hollow mounting bolt with 6" wires

TLA180	5" round, shock proof rubber housing	\$9.59
TLA580	4"x6" rectangle, flood beam	\$24.95

# LED Light Bars & Strip Lighting



## LED Light Bars



- Heavy duty aluminum housing
- 12 or 24 VDC
- Hardwire, 16" leads
- Mounting hardware included
- Lifetime LED warranty! Waterproof rating: IP65



ITEM#	length	flood LED's	spot LED's	raw lumens	effective lumens	Price
TLW495	9"	8	4	2,520	1,550	\$62.95
TLW496	13"	8	16	5,000	2,700	\$68.95
TLW497	22"	24	16	7,500	4,521	\$109.95
TLW498	33"	32	28	12,600	6,777	\$156.95

## Magnetic LED Work Light



- 5" clear acrylic lens
- 6 LED, 1,350 lumens output
- 12-24 volts, 1.5 amp
- Shock resistant & waterproof
- Stainless steel mounting bracket and fasteners
- Includes magnetic base and 30' power cord

TLW480	LED Work Light	\$55.95
--------	----------------	---------

## Interior Dome Lights



TLI411



TLI412

- Built-in on/off switch (Except TLI411)

TLI411	5 3/4" x 2 3/4" x 3/4"	9 LED Sealed Dome Light	\$12.95
TLI412	7 1/4" x 4 3/8" x 1 1/4"	9 LED Sealed Dome Light	\$12.95

## LED Load Equalizer

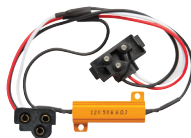

- Use when upgrading incandescent turn signals to LED lights
- Makes turn signal flash at proper flash rate
- Easy plug and go! One required per circuit, 50W, 60hm in-line resistor. Note: Resistors will get very warm, please mount to metal

TLP999	LED load equalizer	\$10.95
--------	--------------------	---------

## LED Strip Lighting w/ Switch



- In-line on/off touch switch for easy use in tool boxes, etc.
- Easy to install with self-adhesive backing
- Sealed. 5-year warranty.

TLSL61019	18" Cool White Strip Light	\$29.95
-----------	----------------------------	---------

## LED Strip Lighting



- Easy to install self-adhesive backing
- Sealed. 5-year warranty. 1 year warranty if applied to exterior surfaces

TLSL61018	18" Cool White Strip Light	\$26.95
TLSL61024	24" Cool White Strip Light	\$34.95
TLSL61036	36" Cool White Strip Light	\$42.95

## In-Line Fuse Holder



HEFH10	Fuse holder, up to 10 AMP ATC (fuse not included)	\$4.99
--------	---	--------

## Heavy Duty Turn Signal Flasher



Incandescent trailer lights often require a heavier flasher. Replaces 12 volt, 2 terminal flashers on most vehicles.

HEFHD	Heavy Duty Flasher	\$5.99
-------	--------------------	--------

## Pulse Preventer



- The Pulse Preventer prevents 4 way flashers from activating brake controls by utilizing a diode. Normally not needed.

HE2180S	Pulse Preventer	\$24.95
---------	-----------------	---------



# Warning Lights & Switches

## LED Beacon Light



- Height: 3.7"
- 2 flash patterns
- 40 Amber LED's
- Base: 5/4" diameter
- Dome: 3 1/2" diameter
- Permanent or Magnetic mount
- Includes 10 ft coiled wire with a cigarette lighter plug.



TLV061 LED Beacon Light \$36.95

## Hardwire Control Switch



- 15' cable
- Up to 10 amp capacity
- Works well to hardwire TLV478 and TLV476
- On/Off button & flash pattern toggle button

TLVC20 Hardwire Control Switch \$22.95

## LED Portable Strobe Light



- Magnetic mount
- 2-D batteries (not included) last 100+ hours
- Clear dome, Amber LED's
- 4" wide x 4 3/4" high
- Can automatically switch off in daylight



TLV064 24 LED AMBER strobe light \$35.95

## Toggle Switch

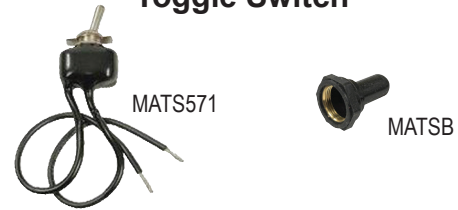

- 20 Amps at 12VDC
- Standard 1 1/16" chrome handle
- Single pole. Single throw. On/off
- Weather resistant plastic coating with O-ring in stem
- MATSB- Protection against water & salt spray

MATS571 Toggle Switch w/ 8" leads \$12.95

MATSB Toggle Switch Boot, 1 1/2"-32 threads \$4.99

## Municipal Strobe Light



- 12-48V
- Dual Flash
- 80 Flashes/min
- 8 joule intensity
- Cast black powder coated aluminum base
- 3 bolt or pipe mount, fasteners and rubber gasket included
- Gell coated circuit board, 2 yr warranty



TLV170 Permanent Mount, 6 1/2" base x 6 1/2" height \$86.95

## LED Mini Light Bar



- Clear lens, 56 high-power amber LED's
- Low-profile design
- Clear acrylic lens
- 10 selectable flash patterns
- Permanent mount or 4 rubber-covered magnetic mounts
- 8 1/2' cord with "on-off" switch and flash pattern selector
- 15" L x 8 1/4" W x 3" H

TLV478 LED AMBER Mini Light Bar \$239.95

## Timken Bearing Grease See page 65,73



## LED Mini Light Bar



- Clear lens, 24 amber LED's
- 10 selectable flash patterns
- Permanent mount or 4 rubber-covered magnetic mounts
- 9 1/2' cord with built-in flash pattern selector and cigarette plug
- 11" L x 6 1/2" W x 2 1/4" H

TLV476 LED AMBER Mini Light Bar \$106.95



# Wireless Light Bars



## Wireless Magnetic Towing Lights



- Brake & taillights, turn signals, 4 way flashers
- 10 diodes per light (requires 8 AA batteries)
- Over 65' of wireless operation
- Standard 4-pin flat magnetic transmitter

**HEMLW20** LED wireless magnetic towing light kit \$129.95

## Magnetic Towing Lights



- Brake & taillights, turn signals, 4 way flashers
- Housing & lens are sonic welded to create a sealed light
- 12 diodes per light, 22 lbs pull magnets
- 20' wiring harness with standard 4-pin flat connector

**HEMLL24** LED magnetic towing light kit \$79.95

## The Wireless Limelight



- 14 LED's!
- Provides stop, tail, & turn lights
- Up to 10 hrs of use between charges
- Recharges from 12V DC cigarette plug (included)
- Two 90 lb pull magnets with non-scratch rubber boots included
- Lifetime warranty on LED's & electronics
- Comes complete with light bar, transmitter, charge, & instructions
- Transmitter provides approximately 1000' range.

**HEMW122** 22" Limelight with 4-pin round transmitter \$279.95

**HEMW1227HD** 22" Limelight with 7HD round pin transmitter \$279.95

**HEMW12RV** 22" Limelight with 7RV transmitter \$279.95

## Magnetic Towing Lights



- Brake & taillights, turn signals, 4 way flashers
- 20' main harness
- 8 lb pull magnets
- Use for under 80" wide loads

**HEML20** Towing light kit, incandescent, 4-flat plug \$39.95

## Magnetic Towing Lights



- Brake & taillights, turn signals, 4 way flashers
- 30' main cord
- 7" between lights
- 70 lb pull magnets

**HEMLL** LED towing kit with case, 4 round plug \$165.95

**HEMLL4F** LED towing kit with case, 4-flat plug \$169.95

## Wireless Light Bar



- Provides stop, tail and turn lights and amber strobe light
- 2 switches: "On/Off" to power up the system & 1 for the strobe light.
- 12V DC charge cord available but not included.
- In the event your batteries fail you can simply plug a cord into the connector and continue to use the light.
- Powerful magnets on the bottom, straps on the top and a handle for ease of carrying.
- Transmitter can be ordered with your choice of plug (\$15 extra)

**HEMMB** 25" LED wireless light bar, 7 HD round pin \$529.95





## Low-Profile Strobe Lights



- 6 CREE diodes
- Synchronize up to 12 units
- 19 flash patterns
- 4½" wide x 1¼" high x ½" deep
- 3 year limited warranty

TLV467

TLV466	Amber Strobe	12V	\$31.95
TLV467	Amber/White Strobe	12V	\$31.95

## Low-Profile Strobe Lights



- Synchronize up to 8 units
- TLV468- 71 flash patterns (70 flashing/1 steady)
- TLV469- 92 flash patterns (88 flashing/4 steady)
- 4¾" wide x 1¼" high x ½" deep
- Lifetime LED warranty!

TLV468

TLV468	6 LED Amber Strobe	12/24V	\$49.95
TLV469	12 LED Amber/White Strobe	12/24V	\$67.95

## LED High Power Strobe Lights



- Aluminum Base & CLEAR Polycarbonate lens
- 10-30VDC, draws less than 1 amp per flasher
- 4¾" x 2" base, 4½" mounting holes
- Can be wired to strobe (or solid function- use your own flasher)
- Quad Strobe Flash (4 flash/second) or "solid light"

TLV460	AMBER Strobe Light	\$49.95
--------	--------------------	---------

## LED High Power Strobe Light

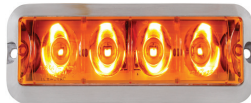

- Aluminum Base & CLEAR Polycarbonate lens
- 10-30VDC, 40% more power and wattage than TLV460
- 2 flash patterns: Slow-single and Fast-quad
- 4¾" x 2" base, 4½" mounting holes

TLV461	AMBER Strobe Light	\$43.95
--------	--------------------	---------

## LED Strobe Control



- Turn any standard LED light into a strobe
- 4 alternating (wig-wag), 2 simultaneous, & 1 random pattern.
- Powers up to 5 amps
- Comes with detailed installation instructions

TLVB	LED Strobe Control Box	\$60.95
------	------------------------	---------

## LED Magnetic Hazard Flashers



TLV274



2-position magnet mount

- Excellent for farm equipment, trucks, cars, boats, trailers, etc.
- Uses 4 AA batteries (not included) last 20-30 hours
- Visible over 1 mile away
- 7" x 3", 2-position (back/bottom) 70 lb magnet

TLV224	24 LED RED flasher	\$37.95
TLV274	24 LED AMBER flasher	\$37.95

## LED Magnetic Hazard Flashers



TLV222



TLV272

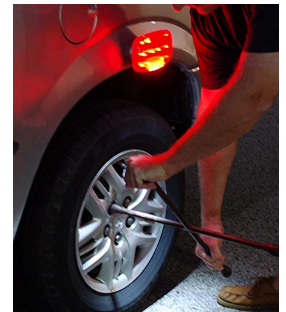

TLV221

- Excellent for farm equipment, trucks, cars, boats, trailers, etc.
- Uses 4 AA batteries (not included) last 20-30 hours
- Visible over 1 mile away
- 6" x 4", two 25 lb magnets

TLV222	18 LED RED flasher	\$27.95
TLV272	18 LED AMBER flasher	\$26.95
TLV221	18 LED RED flasher with work light	\$24.95

## LED Strobe Lights



TLV260



TLV070

- 12 volt DC (TLV070: 12-24V)
- 3 year warranty
- TLV260: quad-flash strobe, 240FPM, includes grommet and plug
- TLV070: six flash strobe, 198FPM, includes grommet & plug

TLV260	6" Oval AMBER 13 LED strobe	\$39.95
TLV070	4" Round AMBER 24 LED strobe	\$38.95

## 4" Round Stop/Tail/Turn Lights



TLS001



TLS016



TLS010



TLS030



TLS018



TLS019



TLS013



TLS022



TLS060



TLS068



TLW014



TLW016



TLW010



TLW011



TLS110

## 4" Round Light Diagrams

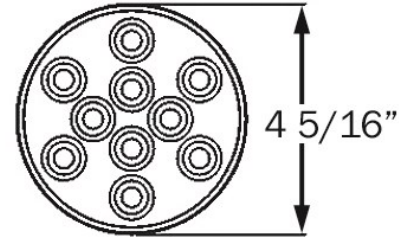

Standard

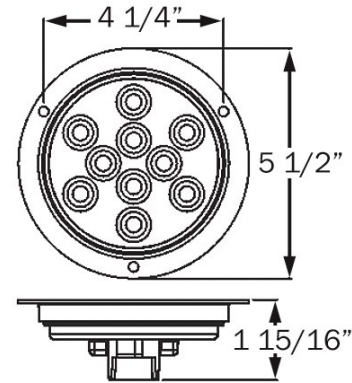

Flange mount

## 4" Round Light Accessories



TLP210



TLB160



TLB168

•Mounting bracket, rubber grommet, & connector are sold separately.

TLS001	Red	ONE LED light	\$7.09
TLS016	Red	7 LED light	\$10.39
TLS010	Red	10 LED light	\$13.29
TLS030	Red	12 LED light, X-shaped Light Guide™	\$17.95
TLS018	Red	21 LED light	\$18.29
TLS019	Red	56 LED light	\$31.95
TLS013	Red	10 LED flange mount light	\$16.29
TLS022	Red 8/White 4	LED S/T/T and backup light, requires two 3-pin plugs	\$28.95
TLS060	Amber	10 LED light	\$15.95
TLS068	Amber	21 LED light	\$18.29
TLW014	White	10 LED utility light	\$23.95
TLW016	White	6 LED DOT approved backup light	\$18.95
TLW010	White	10 LED DOT approved backup light	\$28.95
TLW011	White	36 LED DOT approved backup light	\$43.95
TLS110	Red	Incandescent light, 4 1/4" x 2 1/16"	\$5.09

TLG160	Rubber mounting grommet for 4 1/2" hole	\$1.99
TLB160	Mounting bracket	\$5.29
TLP212	3-pin "straight" plug connector	\$1.79
TLP210	3-pin "right angle" plug connector	\$1.79
TLB663	Single light box	\$36.95
TLB664	Single light box with 2" round on side	\$48.95
TLB167	Double light box	\$57.95
TLB168	Triple light box	\$85.95



## 6" Oval Stop/Tail/Turn Lights



TLS211

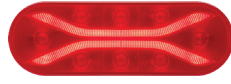

TLS230



TLS214

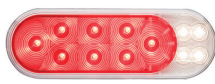

TLS222



TLW214



TLW211



TLS260



TLS266



TLS213



TLW213

## 6" Oval Light Diagrams

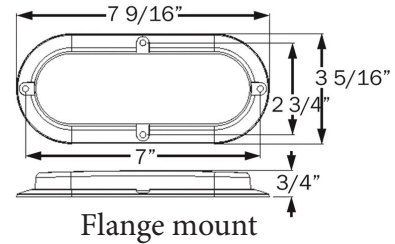
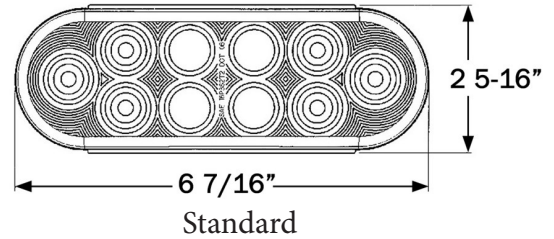

## 6" Oval Light Accessories

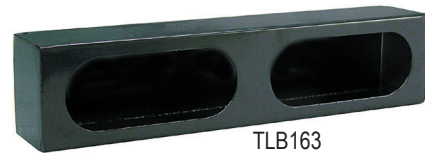

•Mounting bracket, rubber grommet, & connector are sold separately

TLS201	Red	ONE LED light	\$6.99
TLS216	Red	6 LED light	\$9.99
TLS211	Red	10 LED light	\$12.95
TLS230	Red	12 LED light, X-shaped Light Guide™	\$17.95
TLS218	Red	48 LED light	\$24.95
TLS214	Red	12 LED Miro-flex light	\$18.95
TLS213	Red	10 LED surface mount light with wire lead	\$13.95
TLS215	Red	10 LED light w/ clear lens	\$15.95
TLS222	Red 8/White 4	LED S/T/T and backup light, requires two 3-pin plugs	\$28.95
TLS260	Amber	10 LED light	\$16.49
TLS268	Amber	48 LED light	\$31.09
TLS263	Amber	10 LED flange mount light with wire lead	\$15.19
TLS266	Amber	9 LED mid-ship turn signal	\$18.95
TLW214	White	10 LED utility light	\$22.95
TLW213	White	10 LED utility light, flange mount, wire leads	\$20.95
TLW216	White	6 LED DOT approved backup light	\$18.95
TLW210	White	10 LED DOT approved backup light	\$28.95
TLW211	White	36 LED DOT approved backup light	\$43.95
TLS310	Red	Incandescent light	\$7.09
TLS360	Amber	Incandescent light	\$7.09

•TLB386/387/388:	Unpainted for easy welding	
TLG210	Rubber mounting grommet for 6.85" x 2.50" hole	\$1.79
TLB310	Mounting bracket	\$4.59
TLP212	3-pin "straight" plug connector	\$1.79
TLP210	3-pin "right angle" plug connector	\$1.79
TLB383	Single light box	\$30.95
TLB384	Single light box with 2" round on side	\$33.95
TLB386	Single light box	unpainted \$15.95
TLB387	Single light box with 2" round on side	unpainted \$15.95
TLB388	Single light box with 3/4" round on side	unpainted \$15.95
TLB163	Double light box	\$50.95
TLB253	Triple light box	\$72.95



# Stop, Tail, Turn Lights



## Square Stop/Tail/Turn Lights



- Stud mount- 2" between studs
- TLS600/601, TLS610/611, TLS620/621 are water proof
- TLL713: Retail pack includes tail & side marker lens set

TLS710	Right	w/o license light	over 80"	\$7.39
TLS711	Left	with license light	over 80"	\$7.69
TLS715	Right	w/o license light	over 80" submersible	\$7.99
TLS716	Left	with license light	over 80" submersible	\$7.99
TLS720	Right	w/o license light	under 80"	\$6.59
TLS721	Left	with license light	under 80"	\$6.99
TLS610	Right	w/o license light	over 80" 18 LED	\$23.95
TLS611	Left	with license light	over 80" 18 LED	\$27.95
TLS600	Right	w/o license light	under 80" CME LED	\$10.95
TLS601	Left	with license light	under 80" CME LED	\$11.49
TLS620	Right	w/o license light	under 80" 11 LED	\$19.95
TLS621	Left	with license light	under 80" 11 LED	\$22.95
TLL713	Replacement lens kit for TLS710/711/715/716			\$6.09
TLL611	"Box" side replacement lens for over 80"			\$1.95

## Rectangle Stop/Tail/Turn Kits



- Includes 25' of trailer wiring with 4-flat
- LED kits have Lifetime Warranty
- Waterproof
- TLK410 includes 2 amber marker lights

TLK410	LED Light Kit, 7 <sup>5</sup> / <sub>8</sub> "W x 3 <sup>1</sup> / <sub>4</sub> "H x 2 <sup>7</sup> / <sub>8</sub> "D	\$83.95
TLK411	LED Light Kit, 6 <sup>1</sup> / <sub>16</sub> "W x 3 <sup>3</sup> / <sub>8</sub> "H x 2 <sup>1</sup> / <sub>4</sub> "D	\$76.95

## Square Stop/Tail/Turn Kits



- Includes 25' of trailer wiring with 4-flat
- LED kits have Lifetime Warranty
- TLK711 is not submersible
- TLK610 is waterproof

TLK711	Incandescent Light Kit, with side markers	\$24.95
TLK610	LED Light Kit, 4 <sup>3</sup> / <sub>4</sub> "W x 4 <sup>3</sup> / <sub>4</sub> "H x 2 <sup>1</sup> / <sub>16</sub> "D	\$59.95

## Stop/Tail/Turn Lights

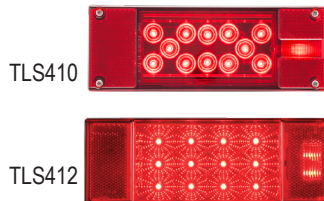

- Waterproof
- Studmount- 2" between studs
- TLS412 & TLS413 are Miro-Flex Design

TLS410	Right	w/o license light	18 LED	over 80"	\$23.95
TLS411	Left	with license light	18 LED	over 80"	\$27.95
TLS412	Right	w/o license light	14 LED	over 80"	\$23.95
TLS413	Left	with license light	14 LED	over 80"	\$28.95

## 5<sup>5</sup>/<sub>16</sub>" Stop/Tail/Turn Lights

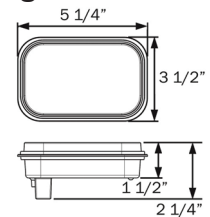

- 5<sup>5</sup>/<sub>16</sub>" x 3<sup>7</sup>/<sub>16</sub>"
- Rubber grommet, & connector are sold separately.

TLS420	Red	12 LED light	\$23.95
TLW420	White	16 LED light	\$35.95
TLS520	Red	Incandescent light	\$7.09
TLG520	Rubber mounting grommet		\$2.89
TLP212	3 pin "straight" plug connector		\$1.79
TLP210	3 pin "right angle" plug connector		\$1.79

## LED Stop/Tail/Turn



- Hardwire
- 16 LED red tail light, 22 LED white backup, 4 LED white license

TLS638	Right	Without license light	LED	\$46.95
TLS639	Left	With license light	LED	\$50.95

### Difference between waterproof and submersible?

- Waterproof lights are sealed and will not let water inside.
- Submersible lights are designed for submersion and have a drain hole at the lowest point.
- Please make sure your wiring connections are sealed so water cannot get in through the wires.



## Thinline Stop/Tail/Turn Light Bars



TLS440

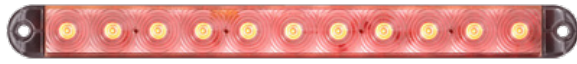

TLS441

- Only 5/8" thick! Surface mount with 14 3/8" mounting holes
- Provides brake, tail lights, and LT or RT (does not provide both!)

TLS440	15 x 1 3/8"	11 LED S/T/T Light Bar	\$15.95
TLS441	15 x 1 3/8"	11 LED S/T/T Light Bar, Clear Lens	\$15.95

## Stop/Tail/Turn Light Bars



TLS430



TLS435

- 1" thick, surface mount with 16 1/8" mounting holes.
- Provides brake, tail lights, and LT or RT (does not provide both!)

TLS430	17 x 1 3/8"	11 LED S/T/T Light Bar	\$15.95
TLS435	17 x 1 3/8"	28 LED GloLight S/T/T Light Bar	\$22.95

## 4 Function LED Bar



- Provides BOTH RT & LT, brake, and tail lights.
- Surface mount with 14 1/2" mounting holes

TLS434	15 1/2 x 1 3/8"	4 Function 11 LED Bar	\$24.95
--------	-----------------	-----------------------	---------

## LED Identification Light Bars



TLM247



TLM248



TLM249

- TLM247: retail pack, 1 diode per light
- TLM248: plastic base, 3 diodes per light
- TLM249- stainless steel, 3 diodes per light
- Replace individual lights with TLM560/510



TLM247	15 1/16"	Red LED bar, 7 1/2" c/c mounting holes	\$14.95
TLM248	15 1/16"	Red LED bar, 7 1/2" c/c mounting holes	\$19.95
TLM249	16 1/2"	Red LED bar, 16 1/16" c/c mounting holes	\$20.95
TLPO30		Replacement ID light bar wiring harness	\$4.99

## Incandescent Identification Light Bars



TLM241



TLM242

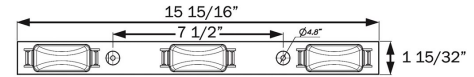

TLM242 illustration

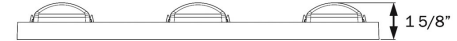

TLM340

- TLM242: Replace individual lights with TLM560/510
- TLM340- stainless steel

TLM241	15 1/16"	Red incandescent bar, 14 3/8" c/c mounting holes	\$7.99
TLM242	15 1/16"	Red incandescent bar, 7 1/2" c/c mounting holes	\$8.99
TLPO30		Replacement ID light bar wiring harness for TLM242	\$4.99
TLM340	14 1/4"	Red incandescent bar, 8 1/2" c/c mounting holes	\$11.95

## LED Identification Light Bars



TLM245



TLM240

- TLM240 - stainless steel

TLM245	17"	Red 3 LED, 16 1/8" c/c mounting holes	\$15.95
TLM240	14 1/4"	Red 9 LED, 8 1/2" c/c mounting holes	\$21.95

## License Plate Lights & Brackets



TLW465



TLW464



TLW485



TLW585



TLW570



TLW180



TLB710

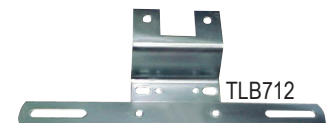

TLB712

- TLB710/712- Fits behind 2" C-C stud STT lights; accepts TLW585

TLW485	5 LED light & poly bracket, 3/8" C-C mount	\$13.09
TLW465	2 LED light, chrome body, 2" C-C mount	\$8.19
TLW464	2 LED light, black body, 2" C-C mount	\$7.49
TLW585	Light with studs on 1 3/4" centers	\$4.99
TLW570	Armored light w/ 2" C-C mount	\$4.29
TLW180	Snap-in light, chrome plated, fits 1/4" hole	\$2.99
TLB710	Black poly license plate bracket	\$1.09
TLB712	Zinc plated steel license plate bracket	\$3.19



## 2" Round Marker Lights



TLM010      TLM060      TLM014

TLM016	Red	1 LED	\$5.09
TLM013	Red	3 LED	\$8.59
TLM010	Red	10 LED	\$7.99
TLM014	Red	9 LED Miro-flex	\$8.99
TLM017	Red	3 LED clear lens	\$8.59
TLM110	Red	Incandescent	\$3.29
TLM066	Amber	1 LED	\$5.09
TLM063	Amber	3 LED	\$8.59
TLM060	Amber	10 LED	\$7.99
TLM064	Amber	9 LED Miro-flex	\$7.99
TLM067	Amber	3 LED clear lens	\$8.59
TLM160	Amber	Incandescent	\$3.29
TLB111	Branch deflector bracket		\$2.29
TLB112	L mounting bracket		\$8.99
TLG010	Rubber mounting grommet for 2 5/16" hole		\$1.19
TLP010	2-pin plug connector		\$1.29

### PC-rated or Miro-flex?

- PC-rated lights are designed to be visible 90° front and back of the center line of the light.
- Miro-flex lights have a built-in specially shaped reflector around the diodes to increase brightness



## Marker Lights for 3/4" Hole



TLM005      TLW005      TLG006



TLM008



TLM003

•These lights install into 3/4" hole

TLM003	Red ID light kit w/ (3) red MCL12 lights and molded harness	\$32.95
TLM005	Red 2 LED, with grommet	\$5.89
TLM006	Red 2 LED, with grommet, clear lens	\$6.99
TLM008	Red 1 LED, 1 1/4" round light with 3/4" grommet	\$9.99
TLM055	Amber 2 LED, with grommet	\$5.89
TLM056	Amber 2 LED, with grommet, clear lens	\$6.99
TLM058	Amber 1 LED, 1 1/4" round light with 3/4" grommet	\$9.99
TLW005	White 2 LED, with grommet	\$7.59
TLG005	Replacement Grommet	\$0.89
TLG006	Stainless Steel Trim Ring for 3/4" Light	\$2.49

## 2 1/2" Round Marker Lights



TLM025      TLM170      TLM030



TLB120

TLB121

TLG020

TLM020	Red	2 LED	\$6.49
TLM023	Red	3 LED	\$8.79
TLM030	Red	13 LED	\$8.99
TLM025	Red	8 LED reflex	\$6.59
TLM120	Red	Incandescent	\$3.29
TLM070	Amber	2 LED	\$6.49
TLM073	Amber	3 LED	\$8.79
TLM075	Amber	8 LED reflex	\$6.59
TLM080	Amber	13 LED	\$8.99
TLM170	Amber	Incandescent	\$3.19
TLG020	Rubber mounting grommet for 2 3/4" hole (most common)		\$1.99
TLG030	Rubber mounting grommet for 3" hole		\$1.75
TLB121	Branch deflector bracket		\$3.29
TLB120	L mounting bracket		\$3.99
TLP010	2-pin plug connector		\$1.29

## 4"x1 1/4" Marker Lights



TLM425

TLB532

TLM478

TLB530

TLM430

•TLB530 has 3" c/c mounting holes

TLM525	Red	Incandescent 2 bulb	\$3.99
TLM425	Red	3 LED	\$6.79
TLM427	Red	4 LED, PC rated	\$7.99
TLM428	Red	4 LED, Miro-Flex	\$8.09
TLM575	Amber	Incandescent 2 bulb	\$3.99
TLM475	Amber	3 LED	\$6.79
TLM477	Amber	4 LED, PC rated	\$7.99
TLM478	Amber	4 LED, Miro-flex	\$8.09
TLM530	Red/Amber	Incandescent fender light	\$4.39
TLM430	Red/Amber	10 LED fender light	\$8.69
TLB530	4"x1 1/4" surface mount bracket w/ plug		\$2.59
TLB532	4"x1 1/4" surface mount fender bracket w/ plug		\$2.79





## 4"x 2" Marker Lights



•These lights are surface mount with 3" c/c holes

TLM310	Red	Incandescent, oval	\$2.99
TLM220	Red	6 LED light, oval	\$8.99
TLM222	Red	10 LED light, bullseye, PC rated	\$11.99
TLM360	Amber	Incandescent, oval	\$2.99
TLM270	Amber	6 LED light, oval	\$8.99
TLM272	Amber	10 LED light, bullseye, PC rated	\$11.99

## Square Stud Mount Marker Lights

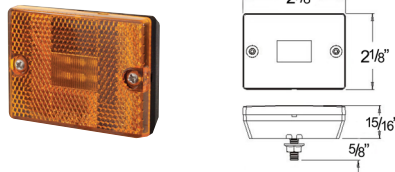

- Reflex lens
- 2-wire
- 1/4" stud size

TLM520	2"x3"	Red	Incandescent stud mount	\$3.49
TLM570	2"x3"	Amber	Incandescent stud mount	\$3.49
TLM420	2"x3"	Red	6 LED stud mount	\$8.49
TLM470	2"x3"	Amber	6 LED stud mount	\$8.49

## LED Marker Lights

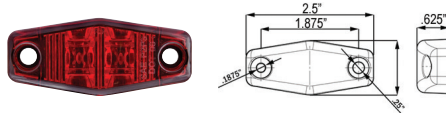

•Self-grounding.

TLM210	2 1/2"x1"	Red	2 LED surface mount, 1 7/8" c/c	\$7.69
TLM260	2 1/2"x1"	Amber	2 LED surface mount, 1 7/8" c/c	\$7.69
TLG260	2 1/2"x1"	Foam mounting gasket for TLM210/260	\$0.39	

## Fender Lights

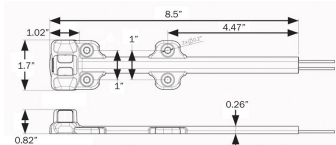

•TLM534/535: Incandescent bulbs

TLM536	LED Reversible Amber/Red Fender light	\$6.79
TLM534	3 7/8"x8 1/2" right fender light, over 80"	\$7.99
TLM535	3 7/8"x8 1/2" left fender light, over 80"	\$7.99

## 2 1/2"x1 1/4" Marker Lights



- TLB410 has 2" c/c mounting holes
- TLW460 has 2 lead wires

TLM510	Red	Incandescent	\$3.39
TLM410	Red	3 LED, PC rated	\$7.49
TLM415	Red	3 LED, miro-flex	\$8.59
TLM560	Amber	Incandescent	\$3.49
TLM460	Amber	3 LED, PC rated	\$7.49
TLM465	Amber	3 LED, miro-flex	\$8.59
TLW460	White	2 LED	\$6.95
TLG510	Rubber mounting grommet for 3.313" x 1.938" hole	\$1.49	
TLB410	2 1/2"x1 1/4" surface mount bracket, black	\$1.99	
TLB414	2 1/2"x1 1/4" surface mount bracket, self ground, chrome	\$2.39	
TLP010	2-pin plug connector	\$1.29	
TLP001	1-pin plug connector for use with TLB414	\$0.69	

## 2 1/8"x1 1/8" Marker Lights

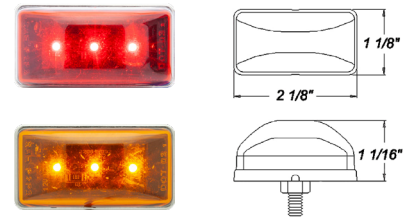

- 1/4" stud size
- Has a chrome ring around the edge

TLM413	Red	3 LED stud mount, with wire lead	\$6.99
TLM463	Amber	3 LED stud mount, with wire lead	\$7.09

## LED Marker Lights

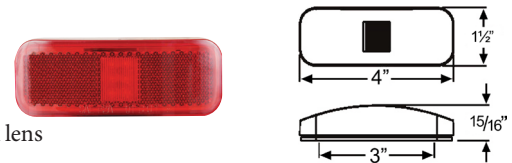

- Reflex lens
- 2-wire

TLM418	4"x1 1/2" Red	6 LED surface mount, 3" c/c	\$8.49
TLM468	4"x1 1/2" Amber	6 LED surface mount, 3" c/c	\$8.49

## Incandescent Marker Lights



- Incandescent bulbs with reflex lens
- Surface mount, 3" c/c holes

TLM540	4"x1 1/2" Red	\$2.59
TLM590	4"x1 1/2" Amber	\$2.59

# Conspicuity Tape & Reflectors



## Conspicuity Tape

ORALITE®

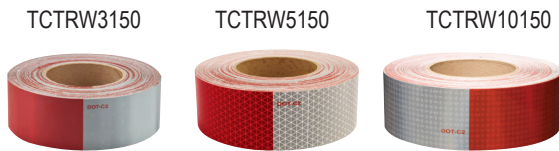

- Red/White reflective tape
- 11" red - 7" white
- DOT approved
- \*TCTRW5151: Kiss cut every 18"
- Custom printed available, minimum 450 rolls, contact for details

TCTRW3150	V42 Conspicuity Tape-3 Year	150' roll	\$85.95
TCTRW5150	V92 Conspicuity Tape-5 Year	150' roll	\$104.95
TCTRW5151	V92 Conspicuity Tape-5 Year	150' roll*	\$104.95
TCTRW10150	V82 Conspicuity Tape-10 Year	150' roll	\$123.95
TCTRW518	V92 Conspicuity Tape-5 Year,	18" piece	\$1.39
TCTRW530	V92 Conspicuity Tape-5 Year,	30' roll	\$23.95

## Conspicuity Tape

ORALITE®

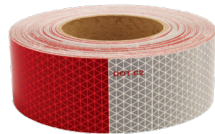

- Red/White reflective tape
- 6" red - 6" white
- DOT approved

TCTRW5158	V92 Conspicuity Tape-5 Year,	150' roll	\$104.95
-----------	------------------------------	-----------	----------

## Conspicuity Tape Retail Packs

ORALITE®



- Red/White reflective tape
- 18" pieces, 11" red - 7" white
- DOT approved

TCTRW5185	V92 Conspicuity Tape-5 Year	5pc pack	\$6.59
TCTRW5186	V92 Conspicuity Tape-5 Year	25pc pack	\$31.95

## Reflector stickers

ORALITE®

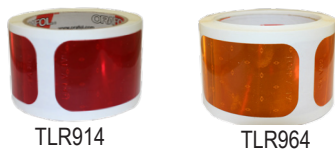

- Red or amber reflector stickers
- 2" x 3½" rectangles
- 7-year warranty
- DOT approved

TLR963	Reflector sticker	Each	Amber	\$0.79
TLR913	Reflector sticker	Each	Red	\$0.79
TLR964	Reflector sticker	100/Roll	Amber	\$59.95
TLR914	Reflector sticker	100/Roll	Red	\$59.95

## White Conspicuity Tape

ORALITE®



- Solid white reflective tape
- DOT approved

TCTRW5154	V92 Conspicuity Tape-5 Year,	150' roll	\$104.95
-----------	------------------------------	-----------	----------

## Reflector

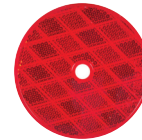

- Screw-on Reflectors

TLR912	3½" Round Reflector, RED	\$1.39
--------	--------------------------	--------

## Emergency Warning Triangles



- Weighted base
- Three-in-one compact case

MERT	1 kit of 3 triangles with plastic storage case	\$39.95
	3 kits or more (price each)	\$37.95

## POD Hazard Warning Lights



- Visible ¼ mile away in daylight conditions!
- Weatherproof: use in rain or snow
- 9 illumination modes, including 350 lumens work lamp
- 3 AAA batteries (not included)
- Versatile mounting options include swivel hook and magnetic base

TLV025	2-pack POD Hazard Warning Light	\$29.95
--------	---------------------------------	---------