



Custom Order Axle Price List

- High-quality, made in USA
- E-Z Lube spindles
- Leaf springs ordered separately
- Braking axles come with electric brakes unless otherwise specified
- Hub face widths over 92" may cause more than 102" legal width
- 5 year warranty on spring axles, 10 year on torsion axles
- Visit dexeraxle.com/resources/manuals for service manuals
- Axles are freight extra to zone A/B/C, see page 166

ITEM#	Capacity	Type	Brake Options	lug circle	Price
ADGSBT0	2,200	Straight	Beam		\$161.00
ADGSIT4	2,200	Straight	Idler	4 on 4"	\$252.00
ADHMBU0	2,200	Torsion	Beam		\$332.00
ADHMUI4	2,200	Torsion	Idler	4 on 4"	\$405.00
ADLSBT0	3,500	Straight	Beam		\$190.00
ADLSIT5	3,500	Straight	Idler	5 on 4.5"	\$293.00
ADLSET5	3,500	Straight	Brakes	5 on 4.5"	\$523.00
ADLDBT0	3,500	Drop	Beam		\$238.00
ADLDIT5	3,500	Drop	Idler	5 on 4.5"	\$355.00
ADLDET5	3,500	Drop	Brakes	5 on 4.5"	\$581.00
ADLMBU0	3,500	Torsion	Beam		\$472.00
ADLMUI5	3,500	Torsion	Idler	5 on 4.5"	\$556.00
ADLMEU5	3,500	Torsion	Brakes	5 on 4.5"	\$726.00
ADPSBT0	5,200	Straight	Beam		\$229.00
ADPSET6	5,200	Straight	Brakes	6 on 5.5"	\$684.00
ADPDET6	5,200	Drop	Brakes	6 on 5.5"	\$757.00
ADPDBT0	5,200	Drop	Beam		\$288.00
ADPMBU0	5,200	Torsion	Beam		\$753.00
ADPMEU6	5,200	Torsion	Brakes	6 on 5.5"	\$978.00
ADRSBT0	6,000	Straight	Beam		\$261.00
ADRSET6	6,000	Straight	Brakes	6 on 5.5"	\$721.00
ADRSET8	6,000	Straight	Brakes	8 on 6.5"	\$756.00
ADRDBT0	6,000	Drop	Beam		\$318.00
ADRDET6	6,000	Drop	Brakes	6 on 5.5"	\$768.00
ADRDET8	6,000	Drop	Brakes	8 on 6.5"	\$827.00
ADRMBU0	6,000	Torsion	Beam		\$753.00
ADRMEU6	6,000	Torsion	Brakes	6 on 5.5"	\$977.00
ADRMEU8	6,000	Torsion	Brakes	8 on 6.5"	\$1035.00
ADSSBT0	7,000	Straight	Beam		\$263.00
ADSSET8	7,000	Straight	Brakes	8 on 6.5"	\$687.00
ADSDBT0	7,000	Drop	Beam		\$319.00
ADSDET8	7,000	Drop	Brakes	8 on 6.5"	\$780.00
ADSMBU0	7,000	Torsion	Beam		\$922.00
ADSMEU8	7,000	Torsion	Brakes	8 on 6.5"	\$1152.00
ADTSBT0	8,000	Straight	Beam		\$344.00
ADTSETF	8,000	Straight	Brakes	8 on 6.5"	\$1,725.00
ADTMBU0	8,000	Torsion	Beam		\$1039.00
ADTMEUF	8,000	Torsion	Brakes	8 on 6.5"	\$2,062.00
ADVSBT0	10K GD	Straight	Beam		\$741.00
ADVSETK	10K GD	Straight	Brakes	8 on 6.5"	\$2,007.00

Custom Order Trailer Axles

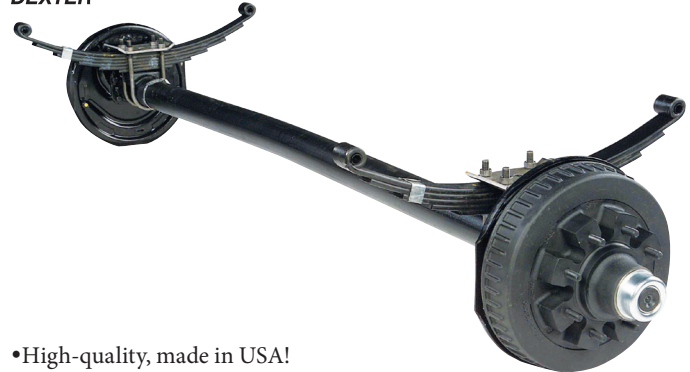

- High-quality, made in USA!
- E-Z Lube spindles
- Leaf springs ordered separately
- Braking axles come with electric brakes unless otherwise specified.
- 5 year warranty on spring axles, 10 year on torsion axles
- Visit dexeraxle.com/resources/manuals for service manual

Fayette Manufacturing Spring Axles

SPECIFICATIONS

-2,200-7,000lb Capacity

-Double-Eye Or Slipper Spring Configurations

-Idler, Electric And Hydraulic Brakes Available

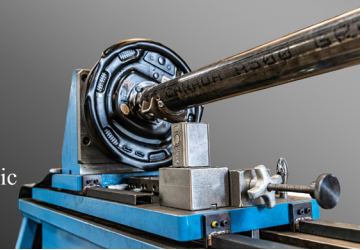

Patented over-tube design gives a 40% stronger fill-in weld

OURS **THEIRS**

- Manufactured in Lewisburg, PA
- Fast order fulfillment! Two weeks or less
- Rush build available for \$125 per axle
- 100% CSA approved components
- Patented spindle design is stronger than industry leader
- 2-coat epoxy paint finish
- 5-Year limited warranty
- Straight or Drop spindles with easy lubrication grease fitting
- If ordered with electric brakes, self-adjusting brakes are standard
- If ordering a beam, spindle parts sold separately (Item# TAP920)
- Please call for pricing



Spring Axle Order Form

To order spring axles, please have the following info:

Axle Type: straight drop

Axle Capacity: _____

Hub Face width (see diagram) _____
 (Hub face widths over 92" may cause more than 102" legal width)

Spring Center width (see diagram) _____

Mount Type: top bottom

Note: springs & U-bolts sold separately

Brake flange (Beam & Idler)

Number of lugs: 4 5 6 8*
 *if 8 lug, choose stud size: 1/2" 5/16" 3/8"

Diameter of lug circle (see diagram)
 4" 4 1/2" 4 3/4" 5" 5 1/2" 6 1/2"

Brake Type: electric drum hydraulic drum
 hydraulic disk idler hub

Lubrication: E-Z Lube grease oil bath

Quantity: _____

Rubber Torflex® Axle Order Form

To order rubber torsion axles, please have the following info:

Axle Capacity: _____

Hub Face Dimensions (see diagram) _____
 (Hub face widths over 92" may cause more than 102" legal width)

Bracket Orientation: Long leg inward Long leg outward

Outside to outside of mounting brackets _____

If side mount AND long leg inward measure bracket width

Bracket Profile: low (standard) 1" high 3" high

Center to center bracket mounting holes (front to rear) _____

Side Mount Hanger Kit Brake flange (Beam & Idler)

Number of lugs: 4 5 6 8*
 *if 8 lug, choose stud size: 1/2" 5/16" 3/8"

Diameter of lug circle (see diagram)
 4" 4 1/2" 4 3/4" 5" 5 1/2" 6 1/2"

Brake Type: electric drum hydraulic drum
 hydraulic disk idler hub

Start Angle _____° (see diagram)

Lubrication: E-Z Lube grease oil bath

Quantity: _____

Straight Spring Axle Measurement

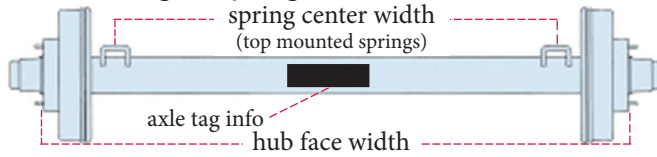

Drop Spring Axle Measurement

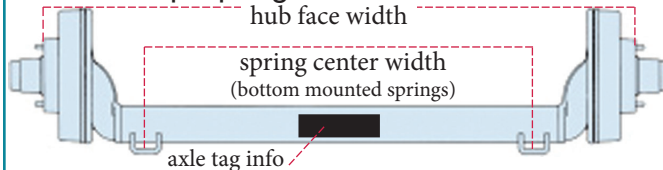

Torsion Axle Measurement

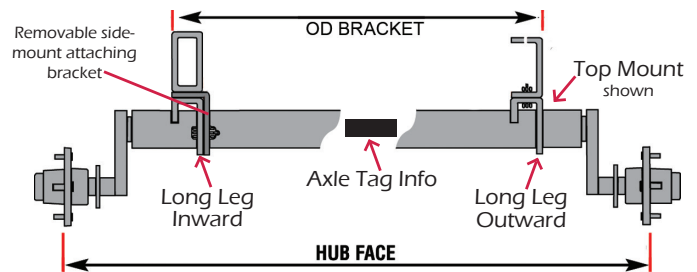

How to Measure Bolt Circle Pattern

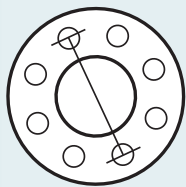

Even

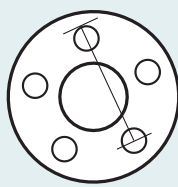

Odd

Even # of bolts...
 measure from center of stud to center of stud directly across diameter.

Odd # of bolts...
 measure from any bolt center to the outside of the second stud.

Torsion Start Angle Diagrams (unloaded)

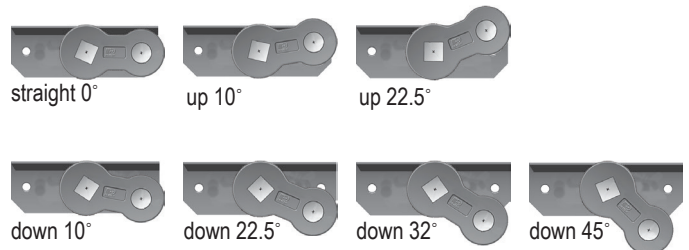

For accurate start angle, please provide the distance from the top of the mounting bracket to the center of the spindle.



In-Stock Spring Axle Beams



5 year warranty
(Excludes brakes)

Made in USA

- E-Z Lube spindles
- Beam includes spindle washers, nuts, and retainers.
- Brakes, drums, springs, & attaching parts sold separately
- 3,500 lb axles have a 2 3/8" axle tube except ADLDBV09470 has 3"
- 6K and 7K axles have 3" axle tube diameter
- Hub face widths over 92" may cause more than 102" legal width
- Axles are freight extra to zone A/B/C, see page 166

ITEM#	Capacity	Drop/ Straight	Hub Face	Spring Center	Spring Seats	Price
ADGSBV06148	2,200	Straight	61	48	bottom	\$163.00
ADLDBV08570	3,500	Drop	85	70	bottom	\$206.00
ADLDBV08770	3,500	Drop	87	70	bottom	\$207.00
ADLDBV09470	3,500	Drop	94	70	bottom	\$276.00
ADLDBV09476	3,500	Drop	94	76	bottom	\$206.00
ADLDBU09500	3,500	Drop	95		loose	\$238.00
ADLDBV09681	3,500	Drop	96	81	bottom	\$206.00
ADLSBV07358	3,500	Straight	73	58	bottom	\$173.00
ADLSBU08400	3,500	Straight	84		loose	\$190.00
ADLSBV08570	3,500	Straight	85	70	bottom	\$190.00
ADLSBT08668	3,500	Straight	86 1/2	68 1/2	top	\$190.00
ADLSBT08672	3,500	Straight	86	72	top	\$173.00
ADLSBV08672	3,500	Straight	86	72	bottom	\$189.95
ADLSBT08874	3,500	Straight	88	74	top	\$173.00
ADLSBV08874	3,500	Straight	88	74	bottom	\$173.00
ADLSBV08974	3,500	Straight	89	74	bottom	\$173.00
ADLSBU09300	3,500	Straight	93		loose	\$190.00
ADLSBV09580	3,500	Straight	95	80	bottom	\$173.00
ADPSBT08668	5,200	Straight	86 1/2	68 1/2	top	\$229.00
ADRDBV09576	6,000	Drop	95	76	bottom	\$305.00
ADRSBV07963	6,000	Straight	79	63	bottom	\$261.00
ADRSBU08400	6,000	Straight	84		loose	\$261.00
ADRSBV09074	6,000	Straight	90	74	bottom	\$252.00
ADSSBV07358	7,000	Straight	73	58	bottom	\$261.00
ADSSBU07600	7,000	Straight	76		loose	\$261.00
ADSSBU07900	7,000	Straight	79		loose	\$261.00
ADSSBU08100	7,000	Straight	81		loose	\$261.00
ADSSBV08774	7,000	Straight	87	74	bottom	\$261.00
ADSSBU08900	7,000	Straight	89		loose	\$261.00
ADSSBU09200	7,000	Straight	92		loose	\$251.00
ADSSBV09480	7,000	Straight	94	80	bottom	\$261.00
ADSSBV09580	7,000	Straight	95	80	bottom	\$261.00
ADSDBV08869	7,000	Drop	88	69	bottom	\$321.00
ADSDBV09477	7,000	Drop	94 1/2	77	bottom	\$319.00
ADSDBV09578	7,000	Drop	95	78	bottom	\$319.00
ADSSEV99580	7,000	Straight	95	80	bottom	\$686.95

*Axle above loaded with electric brakes, 5/16" wheel studs

Complete Axle Package

1. Order the Axle Beam
2. Order Brake Assemblies on page 65 or 67,68 or Disc Brakes on pages 69-73.
3. Order Drum or Idler Hub Kits on page 63.
 - DISCOUNT: If you order your items from the first three categories above to make a complete axle, please request a 5% "Complete Axle" discount off these items.
4. Order Springs on page 55
5. Order Attaching Parts Kit on page 58-59
 - NEED HELP? If you need assistance in choosing the correct item numbers, please call us! We'll help you put together a complete axle kit.
 - Visit dexteraxle.com/resources/manuals for service manuals

Spring Seats



- For round tube axles

ITEM#	Description	Fits Most...	Price
TAP982	Spring Seat for 1 3/4" axles	2.2K	\$5.99
TAP984	Spring Seat for 2 3/8" axles	3.5K	\$6.99
TAP986	Spring Seat for 3" axles	5.2-7K	\$6.39

Spring Mount Conversion Kits



- Converts bottom mount to top mount or vice versa (1 kit per axle).
- Bump stops may be needed to limit axle travel.
- To be used with double-eye springs only

TAP988	2 3/8" Spring Mount Conversion Kit (Most 3.5k axles)	\$76.95
TAP989	3" Spring Mount Conversion Kit (Most 6-7k axles)	\$85.95

Square Axle U-bolt Kits

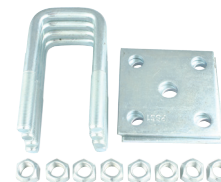

- 4 zinc-plated U-bolts, 8 zinc-plated hex nuts, 2 galvanized tie plates

ITEM#	Axle Width	Spring Width	Price
TAP210	1 3/4"	1 3/4"	\$20.95
TAP212	2 1/8"	1 3/4"	\$24.95



Round Axle U-bolt Kits



TAP202

- Includes 4 U-bolts, 8 Hex nuts, & 2 Tie plates

ITEM#	Axle Diameter	Threads	Spring width	Fits Most...	Price
TAP175	1 3/4"	3/8"	1 3/4"	2k axles	\$27.95
TAP202	2 3/8"	1/2"	1 3/4"	3.5k axles	\$23.95
TAP204	3"	1/2"	1 3/4" & 2"	4.4-7k axles	\$28.95
TAP205	3"	9/16"	1 3/4" & 2"	4.4-7k axles	\$40.95
TAP226	3 1/2"	9/16"	1 3/4" & 2"	8k axles	\$64.95

Heavy Duty Axle U-bolt Kits

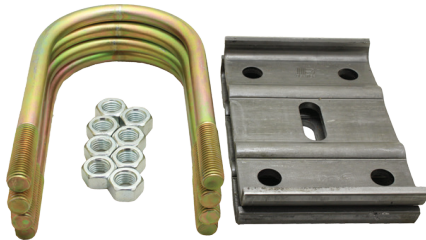

- Includes 4 U-bolts, 8 lock nuts, & 2 Tie plates
- TAP208 fit AL-KO axles
- TAP227/229/230 fit Dexter axles

ITEM#	Axle Diameter	U-bolt length	Spring width	Fits Most...	Price
TAP208	5"	10 1/2"	2 1/2"	10-12k axles	\$94.95
TAP227	5"	9"	2 1/2"	10k GD	\$102.95
TAP229	5"	9"	3"	10k HD	\$115.95
TAP230	5"	9.6"	3"	12-15k	\$153.95

Hardware for 1 3/4" Springs



- Fits most 1 3/4" wide springs, equalizers, and hangers

TAP841	1/16" x 3" Shoulder Bolt	\$3.00
TAP846	1/16" x 3" Shoulder Bolt with grease zerk	\$6.99
TAP888	Lock Flange Nut for TAP841/846	\$0.55
TAP844	1/16" x 3" Bolt	\$3.59
TAP886	Lock Nut for TAP844	\$1.05

Hardware for 2" Springs



- Fits most 2" wide springs, equalizers, and hangers

TAP845	1/16" x 3 1/2" Bolt	\$3.89
TAP886	Lock Nut for TAP845	\$1.05
TAP847	1/16" x 3 1/2" Shoulder Bolt with grease zerk	\$4.39
TAP888	Lock Flange Nut for TAP847	\$0.55

Slipper Leaf Springs



TASS505



- TASS504 fits most Dexter 10K GD (built 10/2003 to 12/2005), 7/8" eye
- TASS505 uses bolt TAP848, nut TAP883 (bushing TAP805 included)
- TASS506/605/755 use bolt TAP850, nut TAP884 (bushing TAP807 included)

ITEM#	capacity	leaves	width	length	Price
TASS504	5,000 lb	5	2 1/2"	30"	\$62.95
TASS505	5,000 lb	5	2 1/2"	30"	\$133.95
TASS506	5,000 lb	5	3"	30"	\$149.95
TASS605	6,000 lb	6	3"	30"	\$179.95
TASS755	7,500 lb	7	3"	30"	\$199.95

Slipper Hook Leaf Springs

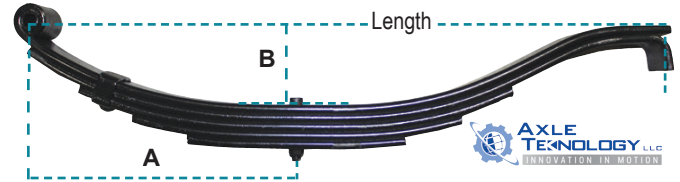

- 9/16" eye

ITEM#	capacity	leaves	width	length	A	B	Price
TASS356	3,500 lb	5	2"	26 1/2"	11"	3 1/4"	\$70.95
TASS401	3,750 lb	6	2"	26 1/2"	12"	3 1/4"	\$72.95
TASS406	4,000 lb	6	2"	29 1/2"	13 1/2"	3 3/4"	\$101.95
TASS405	4,000 lb	7	2"	26 1/2"	11 1/4"	3 1/4"	\$104.95

Double-Eye Leaf Springs



TASD245

- 9/16" eye

ITEM#	capacity	leaves	width	length	Price
TASD174	1,750 lb	3	1 3/4"	25 1/4"	\$43.95
TASD175	1,750 lb	4	1 3/4"	25 1/4"	\$59.95
TASD245	2,400 lb	4	1 3/4"	25 1/4"	\$58.95
TASD306	2,950 lb	5	1 3/4"	25 1/4"	\$68.95
TASD305	3,000 lb	4	1 3/4"	25 1/4"	\$55.00
TASD350	3,500 lb	6	1 3/4"	24 7/8"	\$62.95

Bushings



- For spring eyes and equalizers

ITEM#	Description	inside	outside	width	Price
TAP800	Bronze bushing kit (4 bushings)	1/16"	1 1/16"	1 3/4"	\$17.95
TAP802	Nylon bushing	1/16"	1 1/16"	1 3/4"	\$0.95
TAP803	Nylon bushing	1/16"	1 1/16"	2"	\$1.19
TAP804	Nylon bushing	1/16"	1 1/16"	2"	\$8.69

Axle Suspension



Double Eye Equalizers

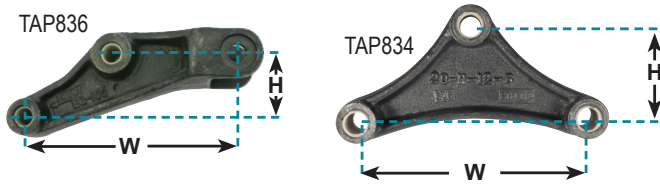

•All holes are 1/16"

TAP836	2" H x 6 3/4" W	\$23.95
TAP833	2" H x 5 3/4" W	\$8.59
TAP835	4" H x 6 1/16" W	\$11.95
TAP834	2 1/2" H x 6 1/8" W	\$9.10
TAP832	2 7/8" H x 7 3/4" W	\$11.95

Slipper Spring Equalizer

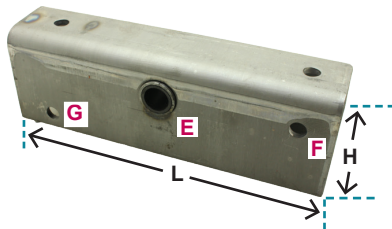

•E = 7/8" hole, F = 1/16" hole
•Hole F requires TAP845 & TAP886

TAP838	12" long	4" high	G = 1/16" hole	\$21.95
TAP839	13" long	3 1/2" high	G = 7/16" hole	\$48.95
TAP840	11" long	3 1/2" high	G = 7/16" hole	\$42.95
TAP849	3/8" x 4 3/4" equalizer bolt w/ grease zerker (hole E)			\$7.39
TAP889	3/8" lock nut			\$2.79
TAP845	Keeper bolt for TAP838, hole G			\$3.89
TAP886	Keeper nut for TAP845			\$1.05
TAP842	Keeper bolt for TAP839/840, hole G			\$2.09
TAP882	Keeper nut for TAP842			\$1.79

Shackle Links

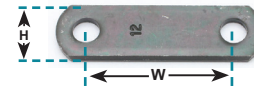

•Both holes are 1/16"

Item#		W	H	Price
TAP864	Shackle Link	2 1/4"	1 1/4"	\$3.09
TAP862	Shackle Link	2 5/16"	1 1/4"	\$3.29
TAP865	Shackle Link	2 3/4"	1 1/4"	\$5.19
TAP863	Shackle Link	3 1/8"	1 1/4"	\$3.49
TAP867	Shackle Link	3 1/2"	1 1/4"	\$5.49

Double Eye Spring Hangers

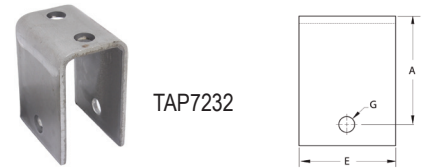

•Up to 8K capacity
•Accepts 1 3/4" wide springs

ITEM#	A	E	G	Price
TAP7214	1.44"	3"	.57	\$7.19
TAP7224	2.46"	3"	.57	\$5.09
TAP7232	3.25"	3"	.57	\$8.49
TAP7242	4.25"	3"	.57	\$10.95

Slipper Spring Hangers

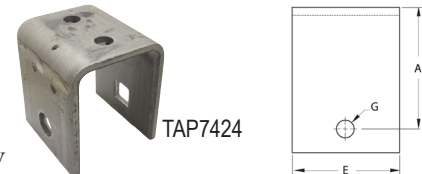

•Up to 8K capacity
•Accepts 2" wide springs

ITEM#	Position	Width	A	E	G	Price
TAP7422	front	2.19"	3.56"	4"	.57	\$24.95
TAP7424	center	3.13"	3.38"	4"	.88	\$26.95
TAP7426	rear	2.19"	5.06"	4"	.57	\$34.95

Equal-i-zer Weight Distribution Hitches

See page 125

THE ORIGINAL
Equal-i-zer
SWAY CONTROL HITCH

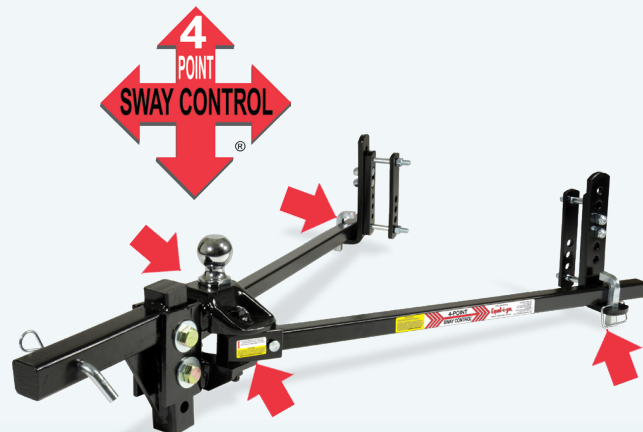



Heavy Duty Equalizers

Dexter 10K GD Equalizers



TAP89242

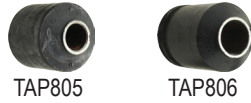

TAP805

TAP806

- E = 1" hole, F = 3/4" hole
- For 2 1/2" springs
- 14" equalizers available - call for details

TAP89242	18 1/2" long	5 1/4" high	\$121.95
TAP89248	24 3/4" long	5 1/4" high	\$123.95
TAP848	3/4"-10 x 4 1/2" spring eye bolt		\$10.95
TAP883	3/4"-10 lock nut		\$5.09
TAP850	1"-8 x 5 1/2" equalizer bolt		\$19.29
TAP8501	1"-8 x 5 1/4" greaseable equalizer bolt		\$21.95
TAP884	1"-8 lock nut		\$6.39
TAP805	Replacement spring eye bushing (2 1/2" long)		\$42.95
TAP806	Replacement equalizer bushing (3 1/4" long)		\$22.95

Dexter 10-15K Equalizers



TAP89342



TAP807

TAP808

- E = 1 1/8" hole, F = 1" hole
- For 3" springs
- 14" equalizers available - call for details

TAP89342	18 1/2" long	6" high	G = 1/2" hole	\$205.95
TAP89348	24 3/4" long	6" high	G = 1/2" hole	\$244.95
TAP850	1"-8 x 5 1/2" spring eye bolt			\$19.29
TAP8501	1"-8 x 5 1/4" greaseable equalizer bolt			\$21.95
TAP884	1"-8 lock nut			\$6.39
TAP851	1 1/8"-7 x 6" equalizer bolt			\$22.95
TAP885	1 1/8"-7 lock nut			\$7.99
TAP852	1/2"-20 x 4 1/2" keeper bolt (hole G)			\$7.09
TBP905	1/2"-20 nylon lock nut			\$0.39
TAP807	Replacement spring eye bushing (3" long)			\$19.95
TAP808	Replacement equalizer bushing (3 3/4" long)			\$22.95

AL-KO Equalizers

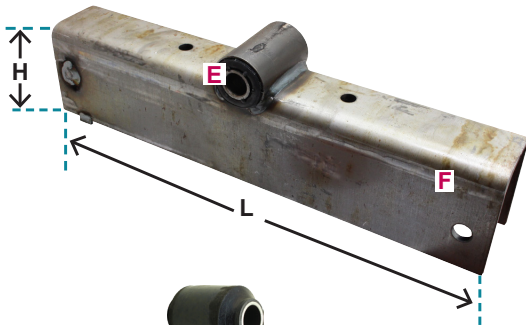

TAP801

- E = 1" hole, F = 3/4" hole
- Fits 10-16K AL-KO axles

TAP898317	21 1/4" long	4 3/4" high	\$139.95
TAP898321	15 3/4" long	4 3/4" high	\$118.95
TAP801	Replacement spring eye bushing (2 1/2" long)		\$24.95

Dexter Bearing Grease



TAB100	Dexter #2 lithium grease, 14 oz. tube	\$15.29
--------	---------------------------------------	---------

WeighSafe Gooseneck Ball Kit

See page 121



Disc or Drum actuators
See pg 75

Dexter Extra Duty Suspension Kit



- Fits a tandem axle setup with 35" axle spacing & 1 3/4" wide springs
- Greaseable equalizers & hardware
- Extra thick shackle links
- Bronze spring & equalizer bushings
- 2- 013-122-04 equalizer 7.75" wide x 2.88" high
- 14- 7/16"-20 flange lock nut 006-092-01
- 2- 1/4" x 2.9" shackle bolt 007-126-00
- 4- 1/4" x 2.9" shackle bolt with zerk 007-187-00
- 8- 1.74" long bronze bushing 014-077-00
- 4- shackle link 018-024-01
- 4- shackle link assembly 018-026-00

TAP8238 K71-449-00 Tandem axle with double eye springs **\$226.95**

Dexter Extra Duty Suspension Kit



- Fits a tandem axle setup with 33" axle spacing & 1 3/4" wide springs
- Greaseable equalizers & hardware
- Extra thick shackle links
- Bronze spring & equalizer bushings
- 2- 013-104-04 equalizer 5.75" wide x 2.03" high
- 14- 7/16"-20 flange lock nut 006-092-01
- 2- 1/4" x 2.9" shackle bolt 007-126-00
- 4- 1/4" x 2.9" shackle bolt with zerk 007-187-00
- 8- 1.74" long bronze bushing 014-077-00
- 4- shackle link 018-024-01
- 4- shackle link assembly 018-026-00
- 6,000 lb. Max Capacity!

TAP8237 K71-359-00 Tandem axle with double eye springs **\$215.95**

Dexter E-Z Flex Suspension Kit



- Fits a tandem axle setup with 35" axle spacing & 1 3/4" wide springs
- Greaseable equalizers & hardware
- Extra thick shackle links
- Bronze spring & equalizer bushings
- 8,000 lb maximum capacity, double eye springs, 35" axle spacing.
- 4- 1/4" Zinc shoulder bolts 007-187-01
- 8- 1.74" bushings 014-077-00
- 4- Zinc shackle link assemblies 018-026-05
- 2- 1/4" Hex locking nuts 006-007-01
- 12- 7/16" Flange nuts 006-092-01
- 2- 1/4" Press-In bolts 007-003-01
- 2- Equalizer Assemblies 013-144-06, 5 5/8" high
- 4- Shackle links 018-024-01
- 2- Grease packets 088-008-00

TAP8245 K71-653-06 E-Z Flex tandem kit, 8,000 lb. **\$442.95**

Dexter E-Z Flex Suspension Kit



- Fits a tandem axle setup with 33" axle spacing & 1 3/4" wide springs
- Greaseable equalizers & hardware
- Extra thick shackle links
- Bronze spring & equalizer bushings
- 6,000 lb maximum capacity, double eye springs, 33" axle spacing.
- 4- 1/4" Zinc shoulder bolts 007-187-01
- 8- 1.74" bushings 014-077-00
- 4- Zinc shackle link assemblies 018-026-05
- 2- 1/4" Hex locking nuts 006-007-01
- 12- 7/16" Flange nuts 006-092-01
- 2- 1/4" Press-In bolts 007-003-01
- 2- Equalizer Assemblies 013-143-06, 5 5/8" high
- 4- Shackle links 018-024-01
- 2- Grease packets 088-008-00

TAP8243 K71-652-06 E-Z Flex tandem kit, 6,000 lb. **\$375.95**



Slipper Spring Attaching Parts Kits

Fits most Dexter, AL-KO, Lippert and imported leaf-spring axles using 2" wide slipper springs



- 2-front slipper spring hanger 3.56" tall
- 2-rear slipper spring hanger 5.06" tall
- 4-shackle bolt $\frac{1}{16}$ " x $3\frac{1}{2}$ " and top lock hex nut $\frac{1}{16}$ " - 18
- Place hangers $24\frac{1}{2}$ " C/C with $26\frac{1}{2}$ " springs

TAP811 Kit for **single axle** with slipper springs **\$55.95**

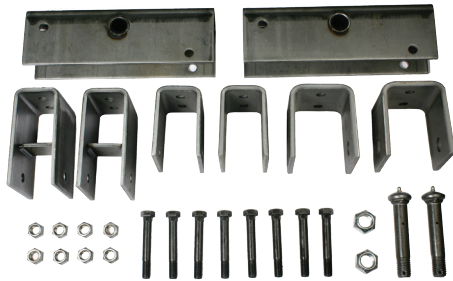

- 2-front slipper spring hanger 3.56" tall
- 2-center slipper spring hanger 3.38" tall
- 2-rear slipper spring hanger 5.06" tall
- 2-equalizer bar 12" long
- Place hangers $29\frac{1}{4}$ " C/C with $26\frac{1}{2}$ " springs. Equals $32\frac{1}{2}$ " axle spacing
- 8-top lock hex nut $\frac{1}{16}$ " - 18
- 8-shackle bolt $\frac{1}{16}$ " x $3\frac{1}{2}$ "
- 2-carriage bolt $\frac{7}{8}$ " x $4\frac{3}{4}$ "
- 2-top lock hex nut $\frac{7}{8}$ "

TAP813 Kit for **tandem axle** with slipper springs **\$134.95**



- 2-front slipper spring hanger 3.56" tall
- 4-center slipper spring hanger 3.38" tall
- 2-rear slipper spring hanger 5.06" tall
- 4-equalizer bar 12" long
- Place center hangers 36" C/C and front/rear hangers $32\frac{3}{4}$ " C/C from center hangers with $29\frac{1}{2}$ " springs. Equals 36" axle spacing.
- 12-top lock hex nut $\frac{1}{16}$ " - 18
- 12-shackle bolt $\frac{1}{16}$ " x $3\frac{1}{2}$ "
- 4-carriage bolt $\frac{7}{8}$ " x $4\frac{3}{4}$ "
- 4-top lock hex nut $\frac{7}{8}$ "

TAP815 Kit for **triple axle** with slipper springs **\$174.95**

Double Eye Spring Attaching Parts Kits

Fits most Dexter, AL-KO, Lippert, and imported leaf-spring axles using $1\frac{3}{4}$ " wide double-eye leaf springs



- 2-front hanger $3\frac{1}{4}$ " tall
- 2-rear hanger $\frac{7}{8}$ " tall
- 4-shackle link $3\frac{1}{8}$ " long
- 6-shackle shoulder bolt $\frac{1}{16}$ " x 3"
- 6-flange lock nut $\frac{7}{16}$ "-20
- Place hangers $25\frac{3}{4}$ " C/C with $25\frac{1}{4}$ " springs

TAP821 Kit for **single axle** with double eye springs **\$31.95**



- 6-hanger $3\frac{1}{4}$ " tall
- 8-shackle link $2\frac{1}{4}$ " long
- 2-triangle equalizer (see size below)
- 14-shackle shoulder bolt $\frac{9}{16}$ " x 3"
- 14-flange lock nut $\frac{7}{16}$ "-20
- TAP8233: Equalizer size: $5\frac{3}{4}$ " wide x 2" tall; Place hangers $29\frac{1}{2}$ " C/C with $25\frac{1}{4}$ " springs. Equals 33" axle spacing.
- TAP8235: Equalizer size: $7\frac{3}{4}$ " wide x $2\frac{7}{8}$ " tall; Place hangers $30\frac{1}{2}$ " C/C with $25\frac{1}{4}$ " springs. Equals 35" axle spacing.

TAP8233 Kit for 33" spaced **tandem axle** with double eye springs **\$72.95**

TAP8235 Kit for 35" spaced **tandem axle** with double eye springs **\$86.95**



- 8-hanger $3\frac{1}{4}$ " tall
- 2-triangle equalizer $5\frac{3}{4}$ " wide x 2" high
- 2-triangle equalizer, forked, $6\frac{3}{4}$ " wide x 2" tall
- 12-shackle link $2\frac{9}{16}$ " long
- 22-shackle shoulder bolt $\frac{1}{16}$ " x 3"
- 22-flange lock nut $\frac{7}{16}$ "-20
- TAP825: Equalizer size: $5\frac{3}{4}$ " wide x 2" tall; Place center hangers 33" apart C/C and front/rear hangers $29\frac{1}{2}$ " C/C from center hangers with $25\frac{1}{4}$ " springs. Equals 33" axle spacing.
- TAP8255: Equalizer size: $7\frac{3}{4}$ " wide x $2\frac{7}{8}$ " tall; Place center hangers 35" apart C/C and front/rear hangers $30\frac{1}{2}$ " C/C from center hangers with $25\frac{1}{4}$ " springs. Equals 35" axle spacing.

TAP825 Kit for 33" spaced **triple axle** with double eye springs **\$111.95**

TAP8255 Kit for 35" spaced **triple axle** with double eye springs **\$154.95**



Replacement Bearings & Races

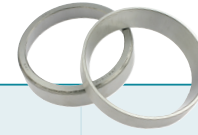

Bearing/cone				Race/cup					
ITEM#	Price	Industry #	ID	ITEM#	Price	Industry #	OD	Fits Most Dexter...	Fits Most AL-KO...
TAB221	\$7.99	44649	1.063	TAB222	\$5.99	44610	1.980	inner & outer 7" hub & outer 10" hub	inner & outer 7" hub & outer 10" hub
TAB223	\$6.99	44643	1.000	TAB222	\$5.99	44610	1.980		inner & outer for BT-8 spindle
TAB231	\$8.99	L68149	1.378	TAB232	\$4.99	L68111	2.362	inner 10" hub	inner 10" hub
TAB241	\$6.99	LM67048	1.250	TAB242	\$5.09	LM67010	2.328	inner 10"x1-1/2", outer 10" 6 lug, outer 5.2k 6 lug	outer 10" hub, (4.4K)
TAB321	\$11.95	25580	1.750	TAB322	\$6.29	25520	3.265	inner 12", 7.2k, 8k, outer 9-10k general duty	inner 12" & 123/8" hub & outer #99 spindle
TAB331	\$8.99	15123	1.250	TAB332	\$5.99	15245	2.441	outer 12" 6k 6lug & 8lug demountable	outer 12" hub w/ 655 lug pattern
TAB341	\$9.99	14125A	1.250	TAB342	\$7.99	14276	2.717	outer 12" hub w/ 865 lug pattern	outer 12" hub w/ 865 lug pattern
TAB351	\$10.95	02475	1.250	TAB352	\$7.99	02420	2.688	outer 7.2k & 8k	outer 12" hub, 8k & 123/8" hub
TAB361	\$14.95	28580	2.000	TAB362	\$6.99	28521	3.625		inner #99 spindle
TAB366	\$14.95	387A	2.250	TAB367	\$10.95	382A	3.813	inner 9 - 10K general duty, outer 10K	
TAB368	\$21.95	395S	2.625	TAB369	\$11.95	394A	4.331	inner 10K	
TAB364	\$18.95	28682	2.250	TAB365	\$10.95	28622	3.844	outer 12-15K	
TAB373	\$22.95	3984	2.625	TAB374	\$13.95	3920	4.438	inner 12-15K	
TAB371	\$22.95	JM511946	2.559	TAB372	\$12.95	JM511910	4.331		inner #120 spindle
TAB376	\$18.95	JM205149	1.969	TAB377	\$8.99	JM205110	3.543		outer #120 & #160 spindle
TAB381	\$59.95	39590	2.625	TAB382	\$41.95	39520	4.438		inner 16K AL-KO

Race & Bearing Kits



TAB608

- Includes bearings, races, grease seal, grease cap, and EZ-lube cap
- TAB407 fits most 1 1/16" diameter spindles
- TAB408: UFP hub/drum (some boat trailers) requires race L68110

ITEM#		Fits Most...	Fits Most...	Price
TAB407	Bearing Kit	4-5 lug	up to 2.2k axles	\$19.95
TAB408	Bearing Kit	4-5 lug	3.5k axles	\$22.95
TAB605	Bearing kit	6 lug	5.2k axles	\$31.95
TAB609	Bearing Kit	6 lug	6k axles	\$33.95
TAB608	Bearing Kit	8 lug	6k — 7k axles	\$36.95
TAB610	Bearing Kit	8 lug	7.2k and 8k axles	\$38.95

Bearing Kits



TAB415

- Includes bearings, grease seal, EZ-lube grease cap, and wheel nuts
- TAB616/618/619: Included 2 1/4" ID grease seal (2 1/8" seal sold separately)

ITEM#		Fits Most...	Fits Most...	Price
TAB415	Bearing Kit	4-5 lug	3.5K axle	\$20.29
TAB616	Bearing Kit	6 lug	5.2K-6K axles	\$26.29
TAB618	Bearing Kit	8 lug 1/2"	6K-7K axles	\$27.95
TAB619	Bearing Kit	8 lug 1/16"	6K-7K axles	\$30.59

Dexter Bearing Grease



TAB100 Dexter #2 lithium grease, 14 oz. tube \$15.29

E-Z Lube® Grease Caps



- Rubber plug sold separately
- E-Z Lube® cap can also be used as standard cap.

ITEM#	Diameter		Fits Most...	Price
TAP262	1.98"	E-Z Lube® grease cap	4-5 lug	\$2.39
TAP264	2.437"	E-Z Lube® grease cap	6 lug	\$2.69
TAP266	2.75"	E-Z Lube® grease cap	8 lug	\$3.29
TAP259		Rubber plug only		\$1.12

Standard Grease Caps



ITEM#	Diameter		Fits Most...	Price
TAP261	1.98"	Standard grease cap	4-5 lug	\$2.09
TAP263	2.437"	Standard grease cap	6 lug	\$3.49
TAP265	2.75"	Standard grease cap	8 lug	\$5.19



Dexter Grease Seals



- Genuine Dexter® replacement parts
- Double lip seals
- Replaces single or double lip seals

ITEM#	Dexter#	ID	OD	Width	Fits Most...	Price
TAS244	010-019-00	1.72	2.56	0.50	3.5K	\$6.95
TAS246	010-036-00	2.250	3.376	.38	5.2K to 8K (after 1998)	\$7.99

Grease Seals

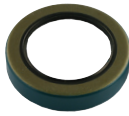

- Double lip seals
- Replaces single or double lip seals

ITEM#	ID	OD	Width	Fits Most...	Price
TAS126	1.25	1.98	0.25	1" spindle (Common on boat trailers)	\$3.49
TAS151	1.50	1.98	0.25	up to 2.2K	\$3.69
TAS176	1.72	2.56	0.50	3.5K	\$2.99
TAS213	2.125	3.371	.313	5.2K to 8K (prior 1998)	\$4.09
TAS226	2.250	3.371	.375	5.2K to 8K (after 1998)	\$4.09

Aluminum Oil Caps



- Heavy duty cast aluminum
- Oil level indication window
- Strong rare-earth magnet in rubber plug attracts metal particles
- Drain plug/grease fitting port
- Requires 2 per axle
- 5 year limited warranty
- Redress kit includes lens & retainer, gasket, magnetic plug, & screws
- Use TAP388. Warranty does not include damage from steel wrenches
- TAP373: has dark window for grease applications

ITEM#	Cross-Over#	Fits Most...	Price
TAP376	Dexter 21-35	Dexter 9-10K general duty (Prior to October 1989) and Dexter/Lippert 6 - 8K Screw-in	\$47.50
TAP377	Dexter 21-36	Dexter 9-10K general duty (After October 1989 - before July 2009) and 10-15K	\$56.99
TAP378	Dexter 21-88	Dexter 9-10K general duty (After July '09 - current)	\$52.25
TAP374	Lippert 693935	Lippert 10-16K	\$61.75
TAP372	AL-KO 568268	AL-KO 7-8K, 1987 & newer screw-in	\$47.90
TAP370	AL-KO 1531029	AL-KO 10-16K	\$61.75
TAP373	021-035-01	Dexter 9-10K general duty (Prior to October 1989) and Dexter/Lippert 6 - 8K Screw-in for grease	\$47.50
TAP387	Redress kit, fits all Valcrum caps		\$14.99
TAP379	Replacement magnetic plug, fits Valcrum & Dexter oil caps		\$5.99
TAP388	Wrench for all Valcrum caps		\$29.99

Dexter Oil Seals

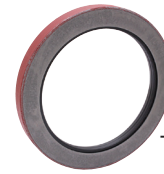

TAS237

- Genuine Dexter® replacement parts

ITEM#	Dexter#	ID	OD	Width	Fits Most...	Price
TAS229	010-063-00	2.250	3.376	.414	12"x2" & 7.2K & 8K	\$52.95
TAS237	010-051-02	2.875	3.880	.414	9K & 10K General Duty	\$51.95
TAS236	010-056-00	3.125	4.506	.605	10K Heavy Duty-15K and AL-KO HD 10K,12K,16K	\$40.95

Oil Seals



TAS234

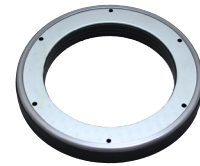

TAS233

ITEM#	ID	OD	Width	Fits Most...	Brand	Price
TAS228	2.250	3.372	.490	12x2 & 7.2K & 8K	Dichtomatik	\$24.95
TAS234	2.750	3.779	.792	AL-KO 10K GD #99 spindle	Dexter	\$54.95
TAS233	2.875	3.875	.515	9K & 10K GD	Dichtomatik	\$23.95
TAS232	3.125	4.500	.595	10K HD - 15K and AL-KO HD 10K,12K,16K	Dichtomatik	\$27.95

Dexter Oil Cap Kits



- Genuine Dexter® replacement parts
- Requires 1 kit per axle

ITEM#	Dexter#	Threads	Fits Most...	Price
TAP276	K71-038-00	2 7/8"-12	9-10K general duty (Prior to October 1989) and 6 - 8K Screw-in	\$23.95
TAP277	K71-148-00	4"-12	9-10K general duty (After October 1989 - before July 2009) and 10-15K	\$33.59
TAP278	K71-704-00	3 1/2"-12	9-10K general duty (After July '09 - current)	\$37.95
TAP379	Replacement magnetic plug, fits Valcrum & Dexter oil caps			\$5.99
TAP279	046-032-00	Replacement rubber plug only		\$4.09

AL-KO Oil Cap Kits



TAP272

- Legacy AL-KO replacement parts
- Requires 2 per axle

ITEM#	Fits Most...	Price
TAP272	7-8K 1987 & newer screw-in	\$25.95
TAP270	10-16K	\$27.95
TAP273	8-16K Replacement plug only	\$5.49



Spindles With Integrated Brake Flange

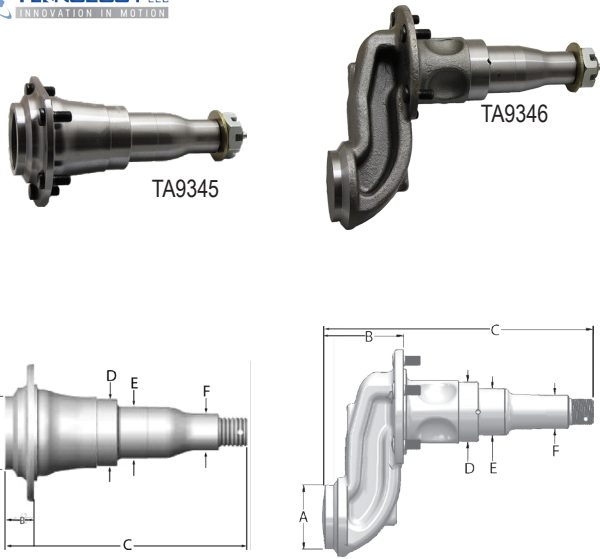

- Integrated brake flange
- Designed for butt weld
- Forged: Custom engineered automotive quality high strength steel
- 1"-14 threads with .190" cotter pin hole
- Includes washer & nut, TAP918 cotter pin sold separately

ITEM#	Spindle	A Stock Dia.	B Stock Lgth.	C Total Lgth.	D Seal ID	E inner bearing ID	F outer bearing ID	Rating	Price
STRAIGHT SPINDLES									
TA9385	#84	1.95"	.875"	6.25"	1.72"	1.376"	1.062"	1,750	\$26.95
TA9345	#42	2.45"	1.00"	8.25"	2.23"	1.749"	1.249"	3,500	\$44.95
DROP SPINDLES									
TA9386	#84	1.95"	3.00"	8.19"	1.72"	1.376"	1.062"	1,750	\$56.95
TA9346	#42	2.45"	2.875"	10.25"	2.23"	1.749"	1.249"	3,500	\$67.95

Spindle Parts

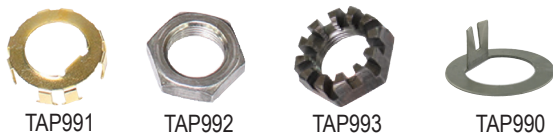

- TAP991/992: fits most axles up to 8K with a "D" flat spindle.
- TAP993: fits most axles up to 8K with cotter pin hole.

ITEM#	Jam Nut Retainer	Size	Style	Price
TAP991	Jam Nut Retainer		D-flat	\$7.99
TAP992	Jam Nut	1"-14		\$4.99
TAP993	Castle Nut	1"-14	Slotted	\$2.99
TAP918	Cotter Pin	1/8" x 1 3/4"	2-8K axles	\$0.49
TAP919	Cotter Pin	1/4" x 3" AL-KO	9-16K axles	\$3.09
TAP990	Tang Washer		"D" flat	\$0.75
TAP994	Flat Washer for "D" shape spindles, up to 4.4K			\$0.69
TAP995	Flat Washer for "D" shaped spindles, 5.2K - 8K			\$0.69

Spindles and Flanges

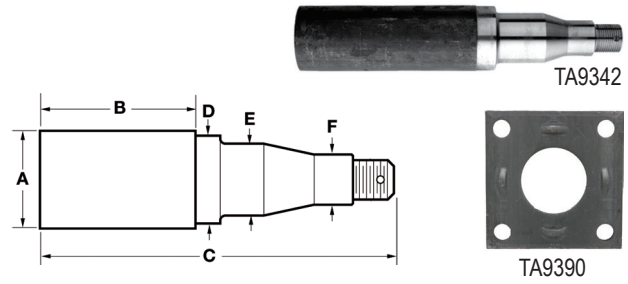

- Bar stock material
- 1"-14 threads with .190" cotter pin hole
- Order TAP920 kit for two washers, nuts, and cotter pins
- TA9307/9317 includes washer & nut, TAP918 cotter pin sold separately
- *Washer may not be needed on some light duty hubs

ITEM#	Spindle	A Stock Dia.	B Stock Lgth.	C Total Lgth.	D Seal ID	E inner bearing ID	F outer bearing ID	Rating	Price
TA9307	BT8	1.25"	3.44"	8.25"	1.23"	.999"	.999"	1,000	\$16.95
TA9316	BT16	1.5"	3.37"	8.25"	1.48"	1.062"	1.062"	1,250	\$23.95
TA9317	BT16	1.5"	3.44"	8.25"	1.48"	1.062"	1.062"	1,250	\$21.95
TA9384	#84	1.75"	3.37"	8.25"	1.72"	1.376"	1.062"	1,750	\$32.95
TA9342	#42	2.25"	6"	11"	2.23"	1.749"	1.249"	3,500	\$64.95
TA9390	Weld-on brake flange for TA9384, 4 bolt								\$9.99
TA9395	Weld-on brake flange for TA9342, 5 bolt								\$13.95

Dexter Spindle Nut Kits



- Fits Dexter spindle

ITEM#	Fits Most...	Price
TAP929	One kit per axle up to 8K axles with "D" flat spindle	\$18.95
TAP927	Two kits per axle 9 - 10K GD axles	\$30.95
TAP928	Two kits per axle 10 - 15K axles	\$38.95

Spindle Nut Kits

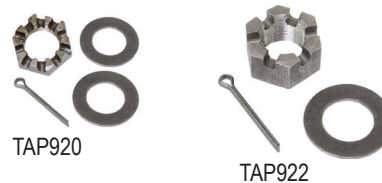

- TAP920 fits standard 1" spindles
- TAP922 fits AL-KO & Hayes spindles

ITEM#	Fits Most...	Price
TAP920	One kit per axle 2K-8K axles	\$10.99
TAP922	Two kits per axle 10K-16K axles	\$28.95



Grease Fittings



- 35 piece grease fitting assortment.
- 6 of the most popular sizes.
- Straight, 45°, and 90° angle all in one case

MAGF Grease Fittings Kit **\$18.95**

Dexter Bearing Grease



TAB100 Dexter #2 lithium grease, 14 oz. tube **\$15.29**

Bearing Protectors

HABP198



- Includes complete set for 1 axle
- Keeps water & dirt out of wheel hubs
- Spring loaded plate keeps grease pushed into bearings.
- HABP198- most popular size

ITEM#	Size	Fits Most...	Price
HABP178	1.78"	light-duty 4 lug hubs	\$16.95
HABP198	1.98"	4-5 lug hubs	\$31.95
HABP2441	2.441"	6 lug hubs	\$32.95
HABP2717	2.717"	8 lug hubs	\$39.95

What size bearing protector do I need?

Measurement conversion:

- 1.780"- approximately 1¾"
- 1.980"- approximately 2"
- 2.441"- approximately 2⅝"
- 2.717"- approximately 2⅞"

Pre-greased Idler Hub Kits



TAH482



- Fully pre-greased kits - easy install!
- Fits most Dexter and Lippert axles
- Includes idler hub, bearings, races, grease seal, standard and easy lube caps, and wheel nuts
- TAH284: Fits 13" and larger wheels

ITEM#	MFG#	Lugs	Circle	Fits Most...	Fits Spindle...	Price
TAH282	17-100	4	4"	2K axles	BT16	\$48.95
TAH284	17-105	5	4½"	2K axles	BT16	\$50.95
TAH482	17-110	5	4½"	2.2K - 3.5K	#84	\$58.95
TAH484	17-120	5	5	3.5K	#84	\$58.95
TAH682	17-135	6	5½"	5.2 - 7K	#42	\$96.95

Idler Hub Kits



TAH264

- Includes idler hub, bearings, races, grease seal, grease cap, and wheel nuts.
- TAH264/164 not for 13" wheels
- Visit dexteraxle.com/resources/manuals for service manuals

ITEM#	Lugs	Circle	Fits Most...	Fits Spindle...	Price	
TAH262	kit	4	4"	2.2K axles	BT16	\$74.95
TAH264	kit	5	4½"	2.2K axles	BT16	\$82.95
TAH462	kit	5	4½"	3.5K axles	#84	\$86.95
TAH164	hub only	Same as TAH264			\$42.95	
TAH106	hub only	Similar to TAH264, accepts 13-15" wheels			\$69.95	

How to Measure Bolt Circle Pattern

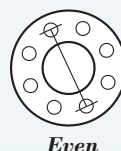

Even

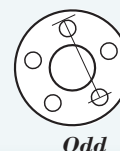

Odd

Even... measure from center of stud to center of stud directly across diameter.
Odd... measure from any bolt center to the outside of the second stud.



Pre-greased Drum Kits



Free Shipping
(over \$99- Zone A)

TBD681



- Fully pre-greased kits - easy install!
- Fits most Dexter and Lippert axles
- Includes studded drum, bearings, races, grease seal, standard and easy lube caps, and wheel nuts
- 12" drum kits include 2 1/4" ID grease seal (2 1/8" seal sold separately)

ITEM#	MFG#	Drum Size	Lugs	Circle	Fits Most...	Price
TBD283	19-140	7" x 1 1/4"	5	4 1/2"	2.2K	\$76.95
TBD481	19-100	10" x 2 1/4"	5	4 1/2"	3.5K	\$79.95
TBD484	19-110	10" x 2 1/4"	5	5"	3.5K	\$101.95
TBD681	19-125	12" x 2"	6	5 1/2"	5.2 - 6K	\$98.95
TBD683	19-130	12" x 2"	8 - 1/2"	6 1/2"	5.2 - 7K	\$144.95
TBD685	19-135	12" x 2"	8 - 9/16"	6 1/2"	5.2-7K	\$146.95

Brake Drums



New!



TBD566

- Genuine Dexter®
- Drum with races & studs

ITEM#	Mfg #	Drum Size	Lugs	Circle	Fits Most...	Price
TBD362	008-247-05	10" x 2 1/4"	5	4.5	3.5K	\$64.95
TBD562	008-201-09	12" x 2"	6	5.5	5.2-6K	\$93.95
TBD564	008-219-04	12" x 2"	8 - 1/2"	6.5	5.2-7K	\$103.95
TBD566	008-219-13	12" x 2"	8 - 9/16"	6.5	5.2-7K	\$109.95

Brake Drums



TBD514

- Interchanges with Dexter® axles
- Drum with races & studs

ITEM#	Mfg #	Drum Size	Lugs	Circle	Fits Most...	Price
TBD312	BD2-545-17	10" x 2 1/4"	5	4 1/2"	3.5K	\$62.95
TBD512	BD2-655-17	12" x 2"	6	5 1/2"	5.2 - 6K	\$95.95
TBD514	BD2-865-17	12" x 2"	8 - 1/2"	6 1/2"	5.2 - 7K	\$101.95
TBD516	BD2-865-37	12" x 2"	8 - 9/16"	6 1/2"	5.2 - 7K	\$104.95

Dexter EZ-Lube Drum Kits



Free Shipping
(Zone A)



- Genuine Dexter® replacement parts
- Fits Dexter E-Z Lube axles
- Kit includes: studded hub/drum, bearings, races, grease seal, E-Z lube grease cap, rubber plug, spindle nut & retainer and wheel nuts.
- TBD468 also includes standard grease cap, castle nut, cotter pin
- 12" drum kits include 2 1/4" ID grease seal (2 1/8" seal sold separately)
- Visit dexteraxle.com/resources/manuals for service manuals

ITEM#	Dexter#	Drum Size	Lugs	Circle	Fits Most...	Price
TBD462	K08-247-94	10" x 2 1/4"	5	4 1/2"	3.5K	\$125.95
TBD468	K08-407-90	10" x 2 1/4"	6	5 1/2"	4.4K	\$205.95
TBD662	K08-201-9B	12" x 2"	6	5 1/2"	5.2 - 6K	\$137.95
TBD664	K08-219-9B	12" x 2"	8 - 1/2"	6 1/2"	5.2 - 7K	\$161.95
TBD666	K08-219-9C	12" x 2"	8 - 9/16"	6 1/2"	5.2 - 7K	\$170.95

Dexter Standard Drum Kits



Free Shipping
(over \$99- Zone A)



- Genuine Dexter® replacement parts
- Fits Dexter regular grease axles
- Kit includes: studded hub/drum, bearings, races, grease seal, grease cap, and wheel nuts.
- 12" drum kits include 2 1/4" ID grease seal (2 1/8" seal sold separately)
- Visit dexteraxle.com/resources/manuals for service manuals

ITEM#	Dexter#	Drum Size	Lugs	Circle	Fits Most...	Price
TBD263	K08-257-91	7" x 1 1/4"	5	4 1/2"	2.2K	\$142.95
TBD461	K08-247-90	10" x 2 1/4"	5	4 1/2"	3.5K	\$113.95
TBD464	K08-249-91	10" x 2 1/4"	5	5"	3.5K	\$121.95
TBD465	K08-250-90	10" x 2 1/4"	6	5 1/2"	3.5K	\$187.95
TBD661	K08-201-9A	12" x 2"	6	5 1/2"	5.2-6K	\$128.95
TBD663	K08-219-9D	12" x 2"	8 - 1/2"	6 1/2"	5.2-7K	\$149.95
TBD665	K08-219-9G	12" x 2"	8 - 9/16"	6 1/2"	5.2-7K	\$158.95

Dexter Bearing Grease



TAB100	Dexter #2 lithium grease, 14 oz. tube	\$15.29
--------	---------------------------------------	---------



Dexter Electric Brake Assemblies



TBA10634



- Fits Dexter® axles
- Genuine Dexter® replacement parts
- Complete brake assembly incl. backing plate, brake shoes, & magnet
- Visit dexteraxle.com/resources/manuals for service manuals
- TBA10636/637: Mounting bolts and nuts included
- 10"x2¼": Mounting bolts included, TBP902 nuts sold separately
- 12"x2": Mounting bolts included, TBP903 nuts sold separately

ITEM#	Dexter#	side	size	mount	rating	Price
TBA07634	K23-047-00	Left	7"x1¼"	4 bolt	2.2K	\$122.95
TBA07635	K23-048-00	Right	7"x1¼"	4 bolt	2.2K	\$122.95
TBA10634	023-026-00	Left	10"x2¼"	4 bolt	3.5K	\$69.95
TBA10635	023-027-00	Right	10"x2¼"	4 bolt	3.5K	\$69.95
TBA10636	K23-462-00	Left	10"x2¼"	4 bolt	4.4K	\$186.95
TBA10637	K23-463-00	Right	10"x2¼"	4 bolt	4.4K	\$186.95
TBA12632	023-105-00	Left	12"x2"	5 bolt	6.0K	\$89.95
TBA12633	023-106-00	Right	12"x2"	5 bolt	6.0K	\$89.95
TBA12642	K23-458-00	Left	12"x2" NEV-R-ADJUST	5 bolt	6.0K	\$152.95
TBA12643	K23-459-00	Right	12"x2" NEV-R-ADJUST	5 bolt	6.0K	\$152.95
TBA12634	023-180-00	Left	12"x2"	5 bolt	7.0K	\$119.95
TBA12635	023-181-00	Right	12"x2"	5 bolt	7.0K	\$119.95
TBA12644	023-464-00	Left	12"x2" NEV-R-ADJUST	5 bolt	7.0K	\$184.95
TBA12645	023-465-00	Right	12"x2" NEV-R-ADJUST	5 bolt	7.0K	\$184.95

Electric Brake Assemblies



TBA12331



- Interchanges with Dexter® axles
- Complete brake assembly incl. backing plate, brake shoes, & magnet

ITEM#	Mfg #	side	size	mount	rating	Price
TBA07330	B07E-21	Left	7"x1¼"	4 bolt	2K	\$75.95
TBA07331	B07E-22	Right	7"x1¼"	4 bolt	2K	\$75.95
TBA10330	B10E-21	Left	10"x2¼"	4 bolt	3.5K	\$59.95
TBA10331	B10E-22	Right	10"x2¼"	4 bolt	3.5K	\$59.95
TBA10340	B10EA-21	Left	10"x2¼" Self-Adjusting	4 bolt	3.5K	\$78.95
TBA10341	B10EA-22	Right	10"x2¼" Self-Adjusting	4 bolt	3.5K	\$78.95
TBA12330	B12E-21	Left	12"x2"	5 bolt	7K	\$81.95
TBA12331	B12E-22	Right	12"x2"	5 bolt	7K	\$81.95
TBA12340	B12EA-21	Left	12"x2" Self-Adjusting	5 bolt	7K	\$102.95
TBA12341	B12EA-22	Right	12"x2" Self-Adjusting	5 bolt	7K	\$102.95

AL-KO Electric Brake Parts

TBS102



ITEM#	Dexter#	Description	Price
TBS102	K71-854-00	AL-KO shoe kit for 10"x2¼" brake	\$89.95
TBPS210	AK568097	AL-KO spring kit for 10"x2¼" brake	\$11.95
TBPS212	AK568096	AL-KO spring kit for 12"x2" brake	\$10.19

Dexter Electric Brake Parts



TBS126



TBM126



ITEM#	Dexter#	Description	Fits Most	Price
TBS106	K71-047-00	Shoe Kit 10"x2¼" (no Nev-R-Adjust)	3.5K	\$59.95
TBS126	K71-127-00	Shoe Kit 12"x2" (no Nev-R-Adjust)	6&7K	\$72.95
TBP930	K71-324-00	Adjuster screw & spring	3.5-7K	\$13.09
TBP932	027-009-00	Magnet clip for 10" & 12" brakes	3.5-7K	\$1.89
TBM106	K71-104-00	Magnet Kit 10"x2¼" green wire	3.5K	\$32.95
TBM126	K71-105-00	Magnet Kit 12"x2" white wire	6.0K	\$31.95
TBM127	K71-125-00	Magnet Kit 12"x2" black wire	7.0K	\$32.95

Electric Brake Parts

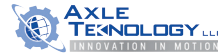

TBS121



ITEM#	Mfg#	Description	Price
TBS101	KB10E-05	Axle-tek Shoe Kit for 10"x2¼" (no self-adjusting)	\$38.95
TBS121	KB12E-05	Axle-tek Shoe Kit for 12"x2" (no self-adjusting)	\$42.95
TBS138	KB12EA-15	Axle-tek LH Shoe Kit for 12"x2" (self-adjusting)	\$46.95
TBS139	KB12EA-25	Axle-tek RH Shoe Kit for 12"x2" (self-adjusting)	\$46.95
TBM101	KB10E-06	Magnet Kit for 10"x2¼" brakes	\$16.95
TBM121	KB12E-06	Magnet Kit for 12"x2" brakes	\$16.99

Brake Mounting Hardware



- Most 2,000-4,400 lb axles with a 4-bolt brake flange use 7/16"x1" bolts (Bolts are typically pressed into new brake-assembly backing plates)

TBP911	7/16"-20 x 7/8"	knurled bolt	\$0.49
TBP906	7/16"-20 x 1"	standard bolt	\$1.29
TBP902	7/16"-20	lock nut	\$0.95

- Most 5,200-7,000 lb axles with a 5-bolt brake flange use 3/8" bolts (Bolts are typically pressed into the axle brake flange on new axles)

TBP910	3/8"-24 x 1"	knurled bolt	\$0.45
TBP904	3/8"-24 x 1"	standard bolt	\$0.89
TBP903	3/8"-24	lock nut	\$0.19

- Most 7,200 & 8,000 lb axles with a 4-bolt brake flange use 1/2" bolts (Hardware is usually not included with axles or brakes)

TBP908	1/2"-20 x 1 3/4"	standard bolt	\$2.09
TBP901	1/2"	lock washer	\$0.49
TBP905	1/2"-20	standard nut	\$0.39

- Most 9K-15K axles with a 7-bolt brake flange use 7/16"x1 3/4" bolts (Hardware is usually not included with axles or brakes)

TBP907	7/16"-20 x 1 3/4"	standard bolt	\$1.99
TBP900	7/16"	lock washer	\$0.79
TBP902	7/16"-20	lock nut	\$0.95

Dexter 9-15K Hubs



TAH860

- Drum sold separately
- Genuine Dexter® replacement hubs with races and wheel studs
- TAH860 fits Dexter® 9-10K General duty axles before July 2009
- TAH861 fits Dexter® 9-10K General duty axles July 2009 till current
- TAH867 does not fit low profile 10" long hub, Torflex, or disc axles

ITEM#	Dexter #	Lugs	Circle	Fits Most...	Price
TAH860	008-288-03	8-5/8"	6 1/2"	9-10K GD	\$189.95
TAH861	008-430-03	8-5/8"	6 1/2"	9-10K GD	\$205.95
TAH866	008-214-05	8-5/8"	6 1/2"	10K not GD	\$247.95
TAH867	008-214-08	8-5/8"	6 1/2"	12K	\$252.95
TAH869	008-401-05	8-M22	275mm	15K	\$542.00

Dexter 8-10K GD Hub & Drums



TBD860

- Genuine Dexter® replacement hub & drum with races and studs
- 12 1/4" x 3 3/8" drum size
- TBD860- Fits Dexter® 9-10K General duty axles before July 2009
- TBD861- Fits Dexter® 9-10K General duty axles after July 2009. Also replaces Dexter® drum 008-415-02

ITEM#	Dexter#	Lubrication	Lugs	Circle	Fits Most..	Price
TBD764	008-285-09	oil	8-9/16"	6 1/2"	8K	\$407.95
TBD765	008-285-10	oil	8-5/8"	6 1/2"	8K	\$423.95
TBD766	008-285-11	grease	8-9/16"	6 1/2"	8K	\$409.95
TBD767	008-285-08	grease	8-5/8"	6 1/2"	8K	\$423.95
TBD860	008-288-05	oil	8-5/8"	6 1/2"	9-10K GD	\$471.95
TBD861	008-430-05	oil	8-5/8"	6 1/2"	9-10K GD	\$499.95

Dexter 9-15K Drums



TBD866

- Genuine Dexter® replacement drums
- Hub sold separately

ITEM#	Dexter#	Drum Size	Lugs	Circle	Fits Most...	Price
TBD850	009-044-01	12 1/4" x 3 3/8"	8-5/8"	6 1/2"	(for TAH860 above)	\$271.95
TBD851	009-123-01	12 1/4" x 3 3/8"	8-5/8"	6 1/2"	(for TAH861 above)	\$294.95
TBD866	009-027-01	12 1/4" x 4"	8-5/8"	6 1/2"	10K not GD	\$395.95
TBD867	009-028-01	12 1/4" x 5"	8-5/8"	6 1/2"	12-15K	\$449.95
TAP977	007-292-00	1/2"-13 x 1 1/2"	mounting bolt for TBD850 & 851			\$3.69
TAP975	007-244-00	1/2"-13 x 1 3/4"	mounting bolt for TBD866 & 867			\$4.99

Axle-Tek Hub & Drums



TBD716

- 12 1/4" x 3 3/8" drum size
- Interchanges with Dexter® axles
- TBD810- Fits Dexter® 9-10K General Duty axles before July 2009
- TBD811- Fits Dexter® 9-10K General duty axles after July 2009
- TBD812- 12 1/4" x 5" drum size

ITEM#	Dexter#	Lubrication	Lugs	Circle	Fits Most..	Price
TBD715	BD-86580-26	oil	8-5/8"	6 1/2"	8K	\$348.95
TBD716	BD-86580-36	grease	8-9/16"	6 1/2"	8K	\$257.95
TBD717	BD-86580-56	grease	8-5/8"	6 1/2"	8K	\$257.95
TBD810	BD-86510-16	oil	8-5/8"	6 1/2"	9-10K GD	\$382.95
TBD811	A008-430-05	oil	8-5/8"	6 1/2"	9-10K GD	\$459.95
TBD812	BD-86512-16	oil	8-5/8"	6 1/2"	12K	\$571.95

8K Lippert Hybrid Brake Drum



Compatible with:

- TAP376/threaded cap
- 25580 inner bearing
- 02475 outer bearing
- TAS226 grease seal
- TAS228 oil seal
- TBA12330/TBA12331 brake assembly
- Fits most Lippert 8K Hybrid axles

ITEM#	MFG#	Lubrication	Drum Size	Lugs	Circle	Price
TBD519	BD-347627	oil or grease	12"x2"	8-5/8"	6 1/2"	\$179.95



Heavy Duty Electric Brakes

Dexter H.D. Electric Brake Assemblies



TBA12746



- Fits Dexter® Axles
- Forward self-adjusting brakes
- Mounting hardware sold separately
- Visit dexteraxle.com/resources/manuals for service manuals

ITEM#	Dexter#	side	size	mount	rating	Price
TBA12744	K23-434-00	Left	12¼"x3¾"	4 bolt	8K	\$399.95
TBA12745	K23-435-00	Right	12¼"x3¾"	4 bolt	8K	\$399.95
TBA12746	K23-450-00	Left	12¼"x3¾"	7 bolt	9-10K GD	\$344.95
TBA12747	K23-451-00	Right	12¼"x3¾"	7 bolt	9-10K GD	\$344.95
TBA12766	K23-438-00	Left	12¼"x4"	7 bolt	10K	\$429.95
TBA12767	K23-439-00	Right	12¼"x4"	7 bolt	10K	\$429.95
TBA12786	K23-442-00	Left	12¼"x5"	7 bolt	12K	\$461.95
TBA12787	K23-443-00	Right	12¼"x5"	7 bolt	12K	\$461.95
TBA12788	K23-446-00	Left	12¼"x5"	7 bolt	15K	\$462.95
TBA12789	K23-447-00	Right	12¼"x5"	7 bolt	15K	\$462.95

H.D. Electric Brake Assemblies



TBA12440

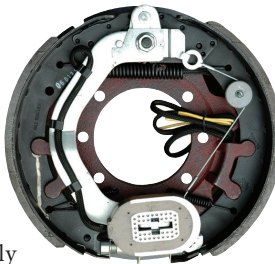

- Forward self-adjusting brakes
- Dust shields included
- Interchanges with Dexter® axles
- Mounting hardware sold separately

ITEM#	Mfg#	side	size	mount	rating	Price
TBA12442	B1208E-11	Left	12¼"x3¾"	4 bolt	8K	\$249.95
TBA12443	B1208E-12	Right	12¼"x3¾"	4 bolt	8K	\$249.95
TBA12440	B1210E-11	Left	12¼"x3¾"	7 bolt	9-10K GD	\$273.95
TBA12441	B1210E-12	Right	12¼"x3¾"	7 bolt	9-10K GD	\$273.95
TBA12764	AK23-438-00	Left	12¼"x4"	7 bolt	10K	\$377.95
TBA12765	AK23-439-00	Right	12¼"x4"	7 bolt	10K	\$377.95
TBA12780	B1212E-21	Left	12¼"x5"	7 bolt	12K	\$326.95
TBA12781	B1212E-22	Right	12¼"x5"	7 bolt	12K	\$326.95

AL-KO H.D. Electric Brake Assemblies

TBA12438



- Fits AL-KO & Hayes Axles
- Reverse self-adjusting brakes
- Mounting hardware included

ITEM#	Dexter#	side	size	mount	rating	Price
TBA12436	K23-532-00	Left	12"x3¾"	4 bolt	8K	\$479.95
TBA12437	K23-533-00	Right	12"x3¾"	4 bolt	8K	\$479.95
TBA12438	K23-528-00	Left	12¼"x3½"	5-6 bolt	10-12K	\$369.95
TBA12439	K23-529-00	Right	12¼"x3½"	5-6 bolt	10-12K	\$369.95

Dexter H.D. Electric Brake Parts



TBS220



TBM135

- Shoe Kits are not for brakes prior to April 2000 with stamped metal backing plate

ITEM#	Dexter#	desc.	brake size	rating	Price
TBS220	K71-499-00	LH Shoe Kit	12¼"x3¾"	8-9K & 10K GD	\$165.95
TBS221	K71-498-00	RH Shoe Kit	12¼"x3¾"	8-9K & 10K GD	\$165.95
TBS240	K71-501-00	LH Shoe Kit	12¼"x4"	10K	\$169.95
TBS241	K71-500-00	RH Shoe Kit	12¼"x4"	10K	\$169.95
TBS250	K71-503-00	LH Shoe Kit	12¼"x5"	12-15K	\$185.95
TBS251	K71-502-00	RH Shoe Kit	12¼"x5"	12-15K	\$185.95
TBM135	K71-378-03	Magnet Kit	Red/Black wire	7.2 - 15K	\$99.95

AL-KO H.D. Electric Brake Parts

TBS124



TBM124

TBM124	K71-863-00	Vented Magnet Kit		10-16K	\$59.95
TBD759	K71-864-00	Armature plate for AL-KO drums		10-16K	\$69.95
TBS124	K71-818-00	Shoe kit for TBA12438 or TBA12439			\$169.95
TBP984	036-140-01	Metal dust cover for TBA12438/9 (need 2 per brake)			\$39.95

H.D. Electric Brake Parts



TBM130



TBM130	KB1208E-06	Magnet kit, white wire		8K	\$49.95
TBM123	KB1210E-06	Magnet kit, yellow wire		9-10K GD	\$41.95
TBM133	KB1212E-06	Magnet kit, gray		12K	\$47.95
TBM134	KB1215E-06	Magnet kit, blue		15K	\$47.95
TBS128	AK71-499-00	LH Shoe Kit	12¼"x3¾"	8-9K & 10K GD	\$91.95
TBS129	AK71-498-00	RH Shoe Kit	12¼"x3¾"	8-9K & 10K GD	\$91.95

Axle-Tek H.D. Electric Brake Assemblies



- Interchanges with Quality/Rockwell American® axles
- Self-adjusting brakes
- Includes dust shield
- Mounting bolts included, TBP902 nuts sold separately

ITEM#	AxleTek#	side	size	mount	rating	Price
TBA12444	B1210E-13	Left	12¼"x3¾"	5 bolt	10K	\$289.95
TBA12445	B1210E-14	Right	12¼"x3¾"	5 bolt	10K	\$289.95



Dexter Hydraulic Brake Assemblies



TBA12678



- Fits Dexter® Axles
- Free backing, does not brake in reverse
- TBA12678/12679: duo-servo, full braking in reverse
- Complete brake assembly (backing plate, shoes, & cylinder)
- 10": Mounting bolts included, TBP902 nuts sold separately
- 12"x2": Mounting bolts typically on flange, nuts sold separately

ITEM#	Dexter#	side	size	mount	rating	Price
TBA10666	K23-344-00	Left	10"x2¼"	4 bolt	3.5K	\$169.95
TBA10667	K23-345-00	Right	10"x2¼"	4 bolt	3.5K	\$169.95
TBA12666	K23-342-00	Left	12"x2"	5 bolt	7K	\$217.95
TBA12667	K23-343-00	Right	12"x2"	5 bolt	7K	\$217.95
TBA12678	K23-336-00	Left	12"x2"	5 bolt	7K	\$230.95
TBA12679	K23-337-00	Right	12"x2"	5 bolt	7K	\$230.95

Axle-Tek Hydraulic Brake Assemblies

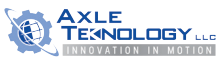

TBA12363



- Complete brake assembly (backing plate, shoes, & cylinder)
- Interchanges with Dexter® axles
- Free backing, does not brake in reverse
- Marine grade: premium dacromet coating, aluminum cylinder, & stainless steel springs

ITEM#	MFG#	side	size	mount	rating	Price
TBA10360	B10H-51	Left	10"x2¼"	4 bolt	3.5K	\$104.95
TBA10361	B10H-52	Right	10"x2¼"	4 bolt	3.5K	\$104.95
TBA10362	B10H-73	Left Marine Grade	10"x2¼"	4 bolt	3.5K	\$120.95
TBA10363	B10H-74	Right Marine Grade	10"x2¼"	4 bolt	3.5K	\$120.95
TBA12360	B12H-51	Left	12"x2"	5 bolt	7K	\$129.95
TBA12361	B12H-52	Right	12"x2"	5 bolt	7K	\$129.95
TBA12362	B12H-73	Left Marine Grade	12"x2"	5 bolt	7K	\$147.95
TBA12363	B12H-74	Right Marine Grade	12"x2"	5 bolt	7K	\$147.95

Hydraulic Brake Repair Parts



- Fits most 10" or 12" hydraulic brake assemblies

ITEM#	Dexter#	Price	
TBP920	054-064-00	Left Wheel Cylinder	\$32.95
TBP921	054-065-00	Right Wheel Cylinder	\$32.95
TBP922	054-156-00	Push rod for wheel cylinder	\$4.99

Dexter H.D. Hydraulic Brake Assemblies



TBA12776

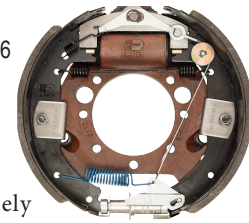

- Fits Dexter® Axles
- Forward self-adjusting brakes
- Duo-servo, full braking in reverse
- Mounting hardware sold separately
- Visit dexteraxle.com/resources/manuals for service manuals

ITEM#	Dexter#	side	size	mount	rating	Price
TBA12754	K23-402-00	Left	12¼"x3¾"	4 bolt	8K	\$446.95
TBA12755	K23-403-00	Right	12¼"x3¾"	4 bolt	8K	\$446.95
TBA12756	K23-410-00	Left	12¼"x3¾"	7 bolt	10K GD	\$449.95
TBA12757	K23-411-00	Right	12¼"x3¾"	7 bolt	10K GD	\$449.95
TBA12776	K23-404-00	Left	12¼"x4"	7 bolt	10K HD	\$479.95
TBA12777	K23-405-00	Right	12¼"x4"	7 bolt	10K HD	\$479.95
TBA12796	K23-406-00	Left	12¼"x5"	7 bolt	15K	\$486.95
TBA12797	K23-407-00	Right	12¼"x5"	7 bolt	15K	\$486.95
TBS226	K71-165-00	LH Shoe Kit	12¼"x3¾"	8K and 10K	GD	\$169.95
TBS227	K71-166-00	RH Shoe Kit	12¼"x3¾"	8K and 10K	GD	\$169.95
TBS252	K71-169-00	LH Shoe Kit	12¼"x5"	12-15K		\$199.95
TBS253	K71-170-00	RH Shoe Kit	12¼"x5"	12-15K		\$199.95

Axle-tek H.D. Hydraulic Brake Assemblies



TBA12750

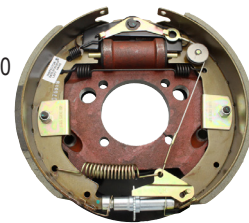

- Forward self-adjusting brakes
- Includes dust shield
- Duo-servo, full braking in reverse
- Interchanges with Dexter® axles
- Mounting hardware sold separately

ITEM#	Mfg#	side	size	mount	rating	Price
TBA12750	B1208H-41	Left	12¼"x3¾"	4 bolt	8K	\$265.95
TBA12751	B1208H-42	Right	12¼"x3¾"	4 bolt	8K	\$265.95
TBA12752	B1210H-41	Left	12¼"x3¾"	7 bolt	10K GD	\$299.95
TBA12753	B1210H-42	Right	12¼"x3¾"	7 bolt	10K GD	\$299.95
TBA12770	B1210H-43	Left	12 ¼"x4"	7 bolt	10K	\$342.95
TBA12771	B1210H-44	Right	12 ¼"x4"	7 bolt	10K	\$342.95
TBA12790	KB1212H-41	Left	12 ¼"x5"	7 bolt	12K	\$395.95
TBA12791	KB1212H-42	Right	12 ¼"x5"	7 bolt	12K	\$395.95

Dexter Dust Shields



TBP989

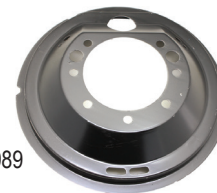

- Fits Dexter electric or hydraulic brakes without parking brake

ITEM#	Dexter#	brake size	mount	rating	Price
TBP988	036-115-20	12¼"x3¾"	4 bolt	8K	\$49.95
TBP986	036-115-21	12¼"x3¾"	7 bolt	10K GD	\$49.95
TBP987	036-115-22	12¼"x4"	7 bolt	10K	\$49.95
TBP989	036-115-23	12¼"x5"	7 bolt	12-15K	\$49.95



Kodiak 3.5-8K Rotors & Studs



TBAD652



TBAD886

•TBAD842/846 include oil cap & require 8K bearing kit TAB610

ITEM#	Kodiak#	rating	description	finish	Price
TBAD622	R/H-10-D-S	3.5K	10" dia. 5-1/2" lugs on 4 1/2" circle	premium	\$116.95
TBAD652	R/H-12-D-S	5.2-6K	12" dia. 6-1/2" lugs on 5 1/2" circle	premium	\$162.95
TBAD744	R/H-133-7-8-D	7K	13" dia. 8-1/2" lugs on 6 1/2" circle	premium	\$245.95
TBAD842	R/H-133-8-9-D-S-C	7&8K	13" dia. 8-3/8" lugs on 6 1/2" circle	premium	\$237.95
TBAD846	R/H-133-8-5-D-S-C	7&8K	13" dia. 8-3/8" lugs on 6 1/2" circle	premium	\$238.95
TBAD884	R/H-LB-1.69		Replacement wheel stud 1/2"-20 x 1.69", up to 6K		\$4.99
TAP933	007-361-00		Replacement wheel stud 1/2"-20 x 2.0", 7-8K		
TBAD886	R/H-LB-2.5-9		Replacement wheel stud 3/16"-18 x 2 1/2", 7-8K		\$9.99
TBAD887	R/H-LB-3.165-5		Replacement wheel stud 3/8"-18 x 3.165", 7-12K		\$12.95

Kodiak 3.5-8K Calipers & Pads



TBAD661



TBAD672



TBAD761



TBAD772



TBAD889

•Kodiak loaded calipers include caliper, pads, guide bolts & sleeves, rubber bushings & rings, and bleeder screw

ITEM#	Kodiak#	rating	description	finish	Price
TBAD661	DBC-225-D	3.5-6K	Loaded caliper for 10/12" rotor	premium	\$137.95
TBAD672	DBC-225-PAD-K	3.5-6K	Pad set, per axle	ceramic	\$56.95
TBAD675	DBC-MHGB	3.5-8K	Guide bolt for 225 & 250 caliper	SS	\$17.95
TBAD676	DBC-MHBS	3.5-8K	Guide bolt sleeve	SS	\$12.95
TBAD677	DBC-MHBSB	3.5-8K	Rubber bushing for sleeve		\$6.95
TBAD678	DBC-NPT-ADP/BBS		Bleed screw	Brass	\$8.76
TBAD760	DBC-250-E	7-8K	Loaded caliper for 13" rotor	E-coat	\$139.95
TBAD761	DBC-250-D	7-8K	Loaded caliper for 13" rotor	premium	\$166.95
TBAD772	DBC-250-PAD-K	7-8K	Pad set, per axle	ceramic	\$79.95
TBAD889	ROTOR/HUB-8-PCAP7-8K		Poly oil cap (not 7K with 1/2" wheel studs)		\$19.95

Timbren Suspension Enhancement
See page 128



Kodiak 9-14K Hubs, Rotors & Studs



TBAD548

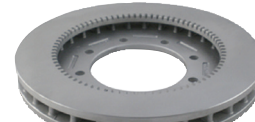

TBAD520



TBAD540



TBAD542

•TBAD520 fits most AL-KO & Rockwell 10K GD axles with Kodiak disc brakes or applications using Kodiak 2-piston 2250 calipers

•TBAD521 fits most Dexter 10K GD axles with Kodiak 1-piston calipers

ITEM#	Kodiak#	description	Finish	Price
TBAD520	RTR-11-10Q	11.3" bolt-on rotor, 10-12K axles	standard	\$147.95
TBAD521	RTR-11-10D	11.6" bolt-on rotor, 10-12K axles	standard	\$148.95
TBAD540	H/S-99-D-S-C	Hub spacer for 9-10K Quality axles	premium	\$322.95
TBAD548	12011-1	Oil cap kit for 10-12K Kodiak hubs		\$19.95
TBAD542	RTR-11-13-BOLT	Rotor mounting bolt for TBAD520/521&540		\$9.99

Kodiak 8-14K Calipers & Pads



TBAD530



TBAD533



TBAD532



TBAD538



TBAD539

•Kodiak Loaded calipers include caliper, pads, guide bolts & sleeves, rubber bushings & rings, and bleeder screw

ITEM#	Kodiak#	rating	description	finish	Price
TBAD530	DBC-338-E	10K	Loaded 338 caliper	E-coat	\$225.95
TBAD531	DBC-338-D	10K	Loaded 338 caliper	Dacromet	\$263.95
TBAD533	DBC-338-PAD-K	10K	Pad set, per axle, for 338 caliper	Ceramic	\$107.00
TBAD527	DBC-338-MHGB	10K	Caliper bolt	Zinc	\$9.99
TBAD528	DBC-338-MHBS	10K	Sleeve for caliper bolt	Zinc	\$14.95
TBAD529	DBC-338-MHBSB	10K	Rubber bushing for sleeve		\$8.99
TBAD678	DBC-NPT-ADP/BBS		Bleeder screw	Brass	\$8.76
TBAD532	DBC-338-HD-E	10-14K	Loaded caliper 338 HD style	E-coat	\$231.95
TBAD536	DBC-2250-E	8-14K	Loaded caliper 2250 for kit TBAD508	E-coat	\$314.95
TBAD538	DBC-2250-PAD-K	12-14K	Pad set, per axle, for 338 HD style and 2250 caliper	Ceramic	\$107.00
TBAD539	DBC-HD-CLIP-REPL		Clip kit for 2250 & 338HD style calipers, two needed per axle	Zinc	\$28.95
TBAD535	DBC-NPT-PLUG		Plug for 338 HD style and 2250 caliper	Brass	\$6.09



Tired of wasting time & money maintaining electric trailer brakes and frequently pulling off drums to inspect brakes? It's time to invest in hydraulic disc brakes!

- Fewer moving parts than drum brakes
- More effective heat dissipation
- Easy access for inspection and maintenance
- Over 50% less stopping distance than drum brakes
- Less sensitive to premature lock-up or wheel skid
- Each kit includes disc brakes for one axle.
- Mounting hardware must be ordered separately, see page 65
- Fits most Dexter & Lippert Axles

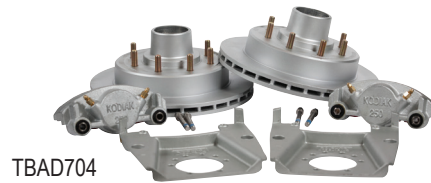

TBAD704

ITEM#	Bolt Circle	Brake Flange	Finish *	poly oil cap included ‡	Clearance Guide **		Price	See page 60 for bearing parts and kit details	
					A	B		Bearing Kit	Price
3.5K axles									
TBAD604	5 - 1/2" on 4 1/2"	4-bolt	premium	No	5.57	5.72	\$439.00	TAB408	\$22.95
5.2K-6K axles									
TBAD634	6 - 1/2" on 5 1/2"	5-bolt	premium	No	6.01	6.8	\$534.00	TAB609	\$33.95
7K axles									
TBAD712	8 - 1/16" on 6 1/2"	5-bolt	E-coat	Yes	5.97	7.56	\$792.00	TAB610	\$38.95
TBAD714	8 - 1/16" on 6 1/2"	5-bolt	premium	Yes	5.97	7.56	\$877.00	TAB610	\$38.95
TBAD704	8 - 1/2" on 6 1/2"	5-bolt	premium	No	5.97	7.56	\$789.00	TAB608	\$36.95

8k - 12k axle kits on next page

‡ Can be used for grease or oil lubrication

* Which finish shall I order on my disc brakes?

Standard: Hub/rotor is raw. Brackets/calipers are E-coated

E-coat: Similar to black powder coat

Premium: Dacromet finish for superior protection from corrosive road salt

Stainless: Stainless steel. Ideal for salt water use

** Measure clearance around spindle

** Clearance Guide

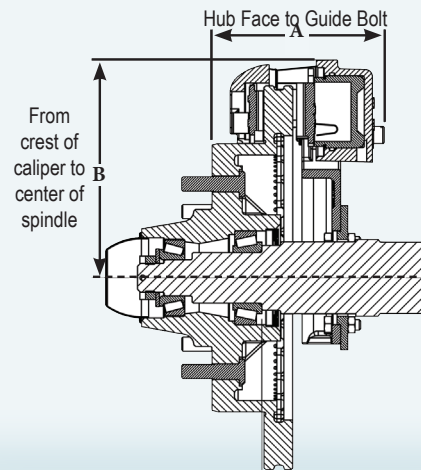

Kodiak 7-8K Spacers

TBAD999



• On rare occasions you might need a spacer below to space out the disc brake kit. Please call for more information

TBAD998	7K flange spacer 0.175" thick, 5 bolt	\$25.95
TBAD999	8K flange spacer 0.313" thick, 4 bolt	\$38.95



Disc 179 feet

Stopping distance for disc brakes.



Drum 340 feet

Stopping distance for electric drum brakes





Kodiak Disc Brake Conversion Kits



TBAD817



TBAD863



TBAD508



TBAD512

- 8 lug on 6½" circle
- For axles equipped with air ride suspension, please call for heavy duty disc brake kit

ITEM#	Fits Most...	Caliper & Bracket *	Wheel Stud	Finish	Clearance Guide **		Price	Bearings & Seals See page 60
					A	B		
8K axles								
TBAD805	Dexter & Lippert	regular	9/16"	premium	6.05	7.56	\$823.00	Inner Bearing: TAB321 Outer Bearing: TAB351 Grease Seal: TAS226 Oil Seal: TAS228
TBAD817	Dexter & Lippert	regular	5/8"	premium	6.05	7.56	\$823.00	
TBAD863	Dexter & Lippert	heavy duty	5/8"	standard	7.48	6.96	\$1108.00	
10K GD drum brake axles								
TBAD506	Dexter axles w/ 8-288-03 hub Axles built before July 2009 usually have 8-288-03 hub	heavy duty	5/8"	premium	9.37	7.06	\$1098.00	Inner Bearing: TAB366 Outer Bearing: TAB321 Oil Seal: TAS233
TBAD508	Dexter leaf spring axles w/ 8-430-03 hub Axles built April 2013 and newer usually have 8-430-03 hub. Axles built July 2009 - April 2013 require purchase of 8-430-03 hub	heavy duty	5/8"	premium	9.45	6.96	\$1256.00	
10K HD - 12K disc brake axles								
TBAD512	AL-KO disk brake axles with #120 spindles This kit replaces AL-KO disc brakes	heavy duty	5/8"	standard	9.48	6.96	\$1697.00	Inner Bearing: TAB371 Outer Bearing: TAB376 Oil Seal: TAS236

* Regular versus Heavy Duty Caliper & Bracket

- Regular calipers mount with two bolts and have one piston
- Heavy Duty calipers clip to a strong yoke and have two pistons
- Heavy Duty brackets are heavier than standard brackets
- TBAD863: 40% more brake pad surface to rotor than TBAD817



Regular caliper & bracket from TBAD817



Heavy Duty caliper & bracket from TBAD863

** Measure clearance around spindle

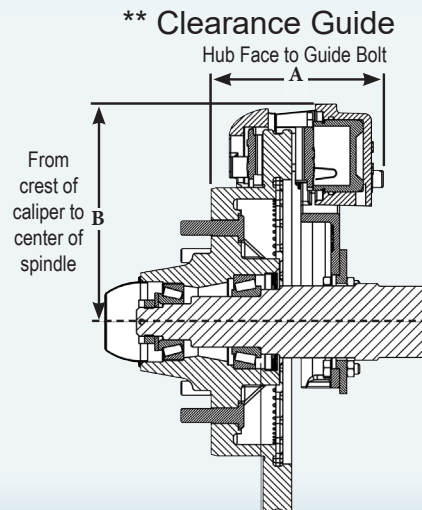

Dexter 6K Disc Brake Parts

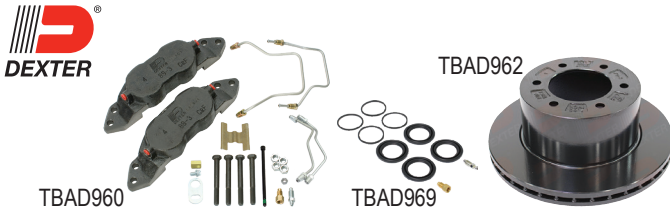

ITEM#	Dexter#	Description	Price
TBAD960	K71-636-00	6K caliper kit for one brake, pads not included	\$435.95
TBAD969	K71-670-00	6-8K caliper repair kit, 2 needed per axle	\$59.95
TBAD971	K71-629-00	6-8K brake pad kit, 1 needed per axle	\$191.95
TBAD963	071-517-00	Replacement hydraulic crossover line	\$23.95
TBAD962	K71-637-00	6K slip-on rotor	\$233.95

Dexter 7K Disc Brake Parts



ITEM#	Dexter#	Description	Price
TBAD970	K71-693-00	7K caliper kit for one brake, pads not included	\$489.95
TBAD969	K71-670-00	6-8K caliper repair kit, 2 needed per axle	\$59.95
TBAD971	K71-629-00	6-8K brake pad kit, 1 needed per axle	\$191.95
TBAD963	071-517-00	Replacement hydraulic crossover line	\$23.95
TBAD978	090-008-01	Left hand anchor yoke	\$91.95
TBAD979	090-008-02	Right hand anchor yoke	\$91.95
TBAD972	008-416-10	7K integral rotor, 8 - 1/2" studs on 6.5" circle	\$355.95
TBAD973	008-416-12	7K integral rotor, 8 - 3/16" studs on 6.5" circle	\$355.95

Dexter 8K Disc Brake Parts



ITEM#	Dexter#	Description	Price
TBAD980	K71-630-00	8K caliper kit for one brake, pads not included	\$469.95
TBAD969	K71-670-00	6-8K caliper repair kit, 2 needed per axle	\$59.95
TBAD971	K71-629-00	6-8K brake pad kit, 1 needed per axle	\$191.95
TBAD983	071-518-00	Replacement hydraulic crossover line	\$34.95
TBAD984	071-840-00	Right hand remote inlet line	\$34.95
TBAD985	071-841-00	Left hand remote inlet line	\$34.95
TBAD988	090-003-01	Anchor yoke	\$94.95
TBAD982	K71-631-00	8K slip-on rotor	\$208.95
TBAD9852	008-399-05	Hub only grease 8 - 9/16" on 6 1/2" circle	\$146.95
TBAD9853	008-399-06	Hub only oil 8 - 9/16" on 6 1/2" circle	\$200.95
TBAD9855	008-399-08	Hub only oil 8 - 3/8" on 6 1/2" circle	\$179.95

Axle-Tek 6-8K Disc Brake Parts



- TBAD170 similar to Dexter K71-693-00
- TBAD171 similar to Dexter K71-629-00
- TBAD180 similar to Dexter K71-630-00

ITEM#	Mfg #	Description	Price
TBAD170	A71-693-00	7K caliper kit for one brake, pads not included	\$213.95
TBAD171	AK71-629-00	6-8K brake pad kit, 1 needed per axle	\$102.95
TBAD180	AK71-630-00	8K caliper kit for one brake, pads not included	\$253.95

DeeMaxx 3.5-8K Rotors

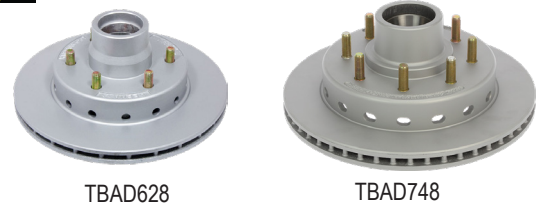

- Superior Maxx dacromet coating
- Interchanges with Kodiak
- TBAD749/848/849 requires 7.2-8K bearing kit TAB610, see pg 60
- TBAD849: utilizes a threaded lube cap TAP376

ITEM#	Deemaxx#	rating	description	Price
TBAD628	RTR/HUB-102-MAXX	3.5K	10" Integral hub/rotor	\$104.95
TBAD658	RTR/HUB-120-MAXX	5.2-6K	12" Integral hub/rotor	\$144.95
TBAD748	RTR/HUB-131-7K-MAXX	7K	13" Integral hub/rotor with 1/2" studs	\$227.95
TBAD749	RTR/HUB-131-8K-56-MAXX	7-8K	13" Integral hub/rotor with 9/16" studs	\$249.95
TBAD848	RTR/HUB-131-8K-62-MAXX	7-8K	13" Integral hub/rotor with 3/8" studs	\$251.95
TBAD849	RTR/HUB-131-62-0-MAXX	7-8K	13" Integral hub/rotor with 3/8" studs	\$251.95

DeeMaxx 3.5-8K Calipers & Pads

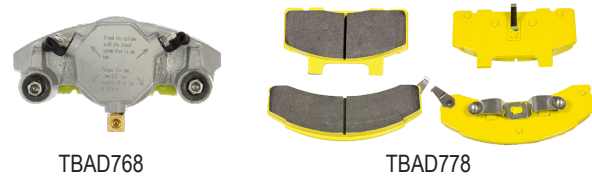

- Superior Maxx dacromet coating
- Interchanges with Kodiak

ITEM#	Deemaxx#	description	Price
TBAD668	CALP-3-6K-MAXX	3.5-6K Caliper with pads	\$130.95
TBAD688	CALP-3-6K-BRAKE-PAD	3.5-6K Pad set, per axle	\$58.95
TBAD768	CALP-7-8K-MAXX	7-8K Caliper with pads	\$171.95
TBAD778	CALP-7-8K-BRAKE-PAD	7-8K Pad set, per axle	\$79.95

DeeMaxx 10-16K Disc Brake Parts



TBAD580

x32

- Fits most 10-16K Lippert axles
- Conversion kit for the following Dexter Drum axles:
 - Dexter 9-10K General Duty hub 008-288-03 (prior to July 2009)
 - Dexter 12K hub 008-214-10
 - Dexter 15K hub 008-401-05
- Individual caliper & pads interchange with Dexter 10-16K

ITEM#	Deemaxx#	description	Price
TBAD580	DBS0-10-16KDL-DW-E-BOX	10-16K disc brake kit	\$1869.00
TBAD582	CALP-10-16KDW-ZINC	Loaded caliper, 2 needed per axle	\$417.95
TBAD583	CALP-10-16KDW-PAD-SM	Brake pad kit, 1 needed per axle	\$192.95
TBAD586	RTR-11-10-16KDL-DW-E	Replacement rotor	\$194.95
TBAD588	RTR-10-16K-BOLT	Rotor mounting stud, ½-13 x 1½"	\$12.95
TBAD584	CALP-3-16K-BS	Caliper bleeder screw with rubber cover	\$7.95
TBAD585	CALP-10-16KDW-BOLT/NUT	Caliper bolt and nut	\$37.95
TBAD589	DBB-10-16KDL-DW-ZINC	Mounting bracket	\$161.95

DeeMaxx Disc Brake Kits

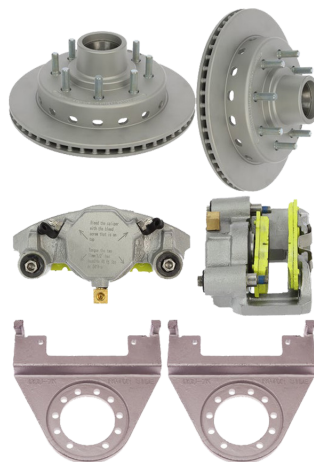

TBAD709

- Includes brackets, loaded calipers, & hub/rotors
- Superior Maxx dacromet coating
- Fits most Lippert and Dexter axles
- Interchanges with Kodiak

See pg 60

ITEM#	Deemaxx#	description	bearing kit	Price
TBAD608	DBI-3.5K-MAXX	3.5K, 10" rotor, 5-½" lugs on 4½" circle	TAB408	\$406.95
TBAD638	DBI-6K-MAXX	5.2-6K, 12" rotor, 6-½" lugs on 5½" circle	TAB609	\$481.95
TBAD708	DBI-7K-MAXX	7K, 13" rotor, 8-½" lugs on 6½" circle	TAB608	\$762.95
TBAD709	DBI-7K-9-MAXX	7K, 13" rotor, 8-9/16" lugs on 6½" circle	TAB610	\$800.95
TBAD818	DBI-8KD10-MAXX	8K, 13" rotor, 8-¾" lugs on 6½" circle	TAB610	\$829.95

Dexter 10-12K Disc Brake Parts



TBAD125



TBAD121



TBAD590



TBAD550



TAH865

- Also fits 9-10K GD disc brake axles built before July 2009
- TBAD125: bleeder screw sold separately (TBAD129)

TBAD125	10-12K caliper assembly for one brake, pads not included	\$383.95
TBAD121	10-12K brake pad kit, 1 needed per axle	\$249.95
TBAD127	Caliper repair kit; includes O-ring, bleeder screw, caliper seal, and dust boot	\$39.95
TBAD129	Bleeder screw for 10-12K caliper, AxleTek	\$7.99
TBAD130	Copper washer for hydraulic fitting on TBAD125	\$3.09
TBAD590	Anchor yoke & 6 O-rings (No 12K torflex axles)	\$173.95
TBAD591	Anchor yoke & 6 O-rings for 12K torflex axles	\$279.95
TBAD550	Replacement rotor (No ABS or 12K torflex axles)	\$214.95
TBAD551	Replacement rotor for 12K torflex axles (No ABS)	\$353.95
TAH865	Replacement hub for 10K Dexter	\$265.95
TAH868	Replacement hub for Dexter 12K disc brakes (No torflex)	\$270.95
TBAD562	Caliper mounting bolt ¾" x 5" long	\$49.95
TBAD561	½"-13 nut for TBAD562 (4 included in TBAD121)	\$2.79
TBAD568	Rotor mounting stud ½"-13 x ½"-20 x 2.53" long	\$5.39
TBAD569	Rotor mounting nut, flange lock nut, ½"-20	\$3.69

Axle-Tek 10-12K Disc Brake Parts



TBAD145



TBAD130



TBAD146



TBAD148

- TBAD145- Similar to Dexter 089-002-02
- TBAD145- Bleeder screw sold separately (TBAD129)

ITEM#	Mfg #	Description	Price
TBAD145	A089-002-02	10-12K caliper for one brake, pads not included	\$191.95
TBAD129	A054-069-00	Bleeder screw for 10-12K caliper	\$7.99
TBAD130	005-169-00	Copper washer for hydraulic fitting on TBAD145	\$3.09
TBAD146	AK71-180-00	10-12K brake pad kit, 1 needed per axle	\$117.95
TBAD148	A070-006-01	Replacement rotor (No ABS or 12K torflex axles)	\$147.95

Electric/Hydraulic Brake Actuators



Brake Rite Actuator



A proven track record of performance and reliability! Designed to be hard wired into your trailers electric system. All components self-contained under the Brake-Rite Cover.



TBH102

- Quickest response in the industry
- Each unit is factory tested
- 5 pistons for faster response time and longer life
- Large 30 cu. inch reservoir- easier to bleed brake lines
- Sealed electronics for superior weather protection
- 18 months limited warranty
- Some factory installed brake controllers require TBH149
- Use HD battery (TBH115) to provide sufficient power to the Brake Rite for quicker response time and for a trailer breakaway.

TBH102	Disc Brakes	1,500 psi	\$1049.00
TBH103	Drum Brakes	1,000 psi	\$1049.00

Electric/Hydraulic Actuator Accessories



- TBH149 is required for Brake Rite actuators if the tow vehicle is equipped with a factory installed brake controller on '06 - '12 Ford and '06 - '13 Chevy/GMC

TBH149	In-line Factory Brake Control Adapter	\$121.95
TBH115	HD Battery for electric/hydraulic actuators	\$104.95
TBH116	Battery Case for TBH115	\$22.95
TBH109	Replacement Filler Cap for Brake Rite, each	\$15.95

Breakaway cables
See page 100



Brake Rite Plug-n-Play Actuator



- Includes same features and benefits of the Brake Rite
- Complete plug-in wiring harness simplifies installation
- 18 months limited warranty
- Some factory installed brake controllers require TBH112
- Use HD battery (TBH115) to provide sufficient power to the Brake Rite for quicker response time and for a trailer breakaway.

TBH101	Disc Brakes	1,500 psi	\$1210.00
--------	-------------	-----------	-----------

Brake Rite Plug-n-Play Accessories



TBH112

- TBH112 is required if the tow vehicle is equipped with a factory installed brake controller on '06 - '12 Ford and '06 - '13 Chevy/GMC

TBH112	Factory Brake Control Adapter for plug n play models	\$127.95
TBH115	HD Battery for electric/hydraulic actuators	\$104.95
TBH116	Battery Case for TBH115	\$22.95
TBH109	Replacement Filler Cap for Brake Rite, each	\$15.95

Dexter Electric/Hydraulic Actuators



TBH122

- Four wire hookup
- Solid-state electronics work with most standard brake controllers
- Large brake fluid reservoir and self-priming pump
- Goretite® seals protect electronics from water and elements
- 2 year limited warranty
- TBH149 is required for '17 and newer Chevy/GMC pickups with factory installed brake controller
- Use HD battery (TBH115) to provide sufficient power to the actuator for quicker response time and for a trailer breakaway.

TBH122	Disc Brakes	1,600 psi	\$981.95
TBH123	Drum Brakes	1,000 psi	\$981.95



Electric/Hydraulic Brake Actuators

Hydrastar Actuator



New!



- Sealed, extruded, anodized aluminum housing (not cast or plastic)
- Vented end plate
- 2-year warranty from date of purchase
- Some factory installed brake controllers require TBH189

TBH182	Disc Brakes	1,600 psi	\$923.00
TBH183	Drum Brakes	1,000 psi	\$923.00
TBH189	Controller adapter module		\$169.95
TBH188	Replacement filler cap		\$14.95

Deutsche Hydrapro Actuator



New!



- High powered DC motor and quality pump provides reliability
- Weatherproof alloy case protects components from elements
- Robust electronics board, protective coating for corrosion resistance
- 2 year warranty from date of purchase
- Some factory installed brake controllers require TBH199

TBH192	Disc Brakes	1,600 psi	\$769.95
TBH193	Drum Brakes	1,000 psi	\$769.95
TBH199	DH Compatibility Controller		\$129.95

Hydrastar Large Reservoir Actuator



New!



- Larger, 16 oz. capacity reservoir, about 2" longer overall
- Marine grade, built to withstand aquatic environments
- Sealed, extruded, anodized aluminum housing (not cast or plastic)
- Vented end plate, Stainless steel hardware, EPDM gaskets
- 2-year warranty from date of purchase
- Some factory installed brake controllers require TBH189

TBH181	Disc Brakes	1,600 psi	\$923.00
TBH184	Drum Brakes	1,000 psi	\$923.00
TBH189	Controller adapter module		\$169.95
TBH188	Replacement filler cap		\$14.95



Echo Underdash Brake Controller
See page "HE51180" on page 97

Curt BetterWeigh
See page 126





Brake Line Kits



TBH130

TBH132

TBH142

- Complete brake line kit includes everything you need to replace your existing lines or switch from electric to hydraulic brakes.
- Includes 15 ft main line and 72" axle lines
- All fittings have 3/8"—24 threads
- Torsion kit hoses have 90° caliper end with 3/8"—24 male threads
- AL-KO & Dexter 10-12K calipers require 7/16"—20 TBH150 adapter

TBH130	Single	Spring axle, drum brake line kit	\$65.95
TBH132	Tandem	Spring axle, drum brake line kit	\$107.95
TBH137	Add-on	Spring axle, drum brake line kit	\$55.95
TBH140	Single	Torsion axle or disc brake line kit	\$103.95
TBH142	Tandem	Torsion axle or disc brake line kit	\$172.95
TBH147	Add-on	Torsion axle or disc brake line kit	\$90.95

Brake Line Parts

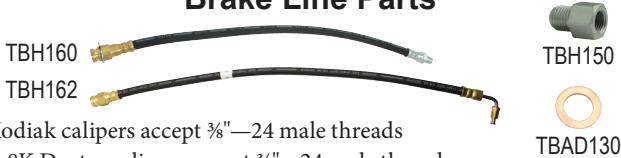

TBH160

TBH162

TBH150

TBAD130

- Kodiak calipers accept 3/8"—24 male threads
 - 6-8K Dexter calipers accept 3/8"—24 male threads
 - 9-12K Dexter calipers accept 7/16"—20 male threads
- | | | |
|---------|---|---------|
| TBH160 | 18" Flex Hose, 3/8"—24 female and 7/16"—20 male | \$26.95 |
| TBH161 | 18" Flex Hose, 3/8"—24 female and 3/8"—24 male | \$20.95 |
| TBH162 | 21" Flex Hose 3/8"—24 female and 90° 3/8"—24 male | \$20.95 |
| TBH150 | Adapter, 3/8"—24 female to 7/16"—20 male | \$19.95 |
| TBAD130 | Copper washer for TBH160 & TBH150 | \$3.09 |
| TBH155 | 6" Brake Line Extension, 3/8"—24 male threads | \$4.99 |
| TBH156 | 12" Brake Line Extension, 3/8"—24 male threads | \$5.99 |

Brake-Line Fittings



TBH170

TBH171

TBH172

TBH173

- Forged brass with wrench fittings
- | | | | |
|--------|----------|------------------------|--------|
| TBH170 | Coupling | 3/8"—24 female threads | \$6.99 |
| TBH171 | Elbow | 3/8"—24 female threads | \$6.99 |
| TBH172 | Tee | 3/8"—24 female threads | \$6.99 |
| TBH173 | Cross | 3/8"—24 female threads | \$7.99 |

Surge Actuators

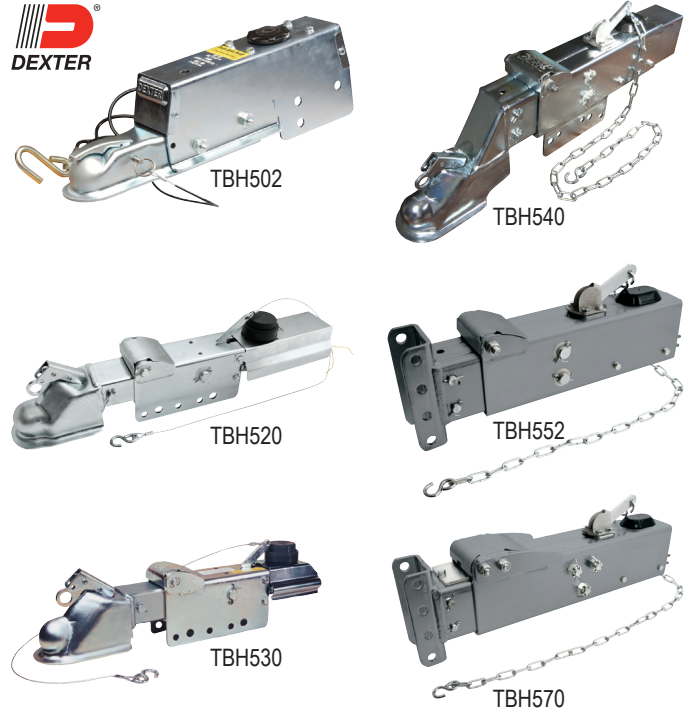

TBH502

TBH540

TBH520

TBH552

TBH530

TBH570

- Fits 3" wide trailer tongue & 2 5/16" ball
- TBH502- Fits 1 7/8" or 2" ball
- Drum brake models should be used with free-backing trailer brakes
- Disc brake models include a reverse solenoid

ITEM#	MFG#	Description	GTW/TW	Price
TBH502	Model 60	drum brakes	7,500/750	\$319.95
TBH520	Model 6	disc brakes	8,000/800	\$504.95
TBH530	Model 6	drum brakes	8,000/800	\$477.95
TBH540	Model 10	disc brakes	12,500/1,250	\$714.95
TBH552	Model 10	drum brakes	12,500/1,250	\$569.95
TBH570	Model 20	drum brakes	20,000/2,000	\$762.95

Surge Actuators



- Fits 3" wide trailer tongue, 2" ball
- EZ latch design
- Drum brake models should be used with free-backing trailer brakes
- Disc brake models include a reverse solenoid

ITEM#	MFG#	Description	GTW/TW	Price
TBH512	8705001	drum brakes	7,000/700	\$175.95
TBH514	8705101	disc brakes	7,000/700	\$243.95