

## Tubular Ball Mounts



- 1" ball hole
- Fits 2" standard receivers
- Uses 5/8" pin & clip (not included)
- Tongue Weight is 10% of capacity
- Length is measured from pin hole to ball hole
- Heavy duty Black Powder Coated tubular steel

### 2" Drop Tubular Ball Mounts

HMT202	2" drop, 7 1/4" long	7,500 lb capacity	\$22.95
HMT202L	2" drop, 10 1/2" long	7,500 lb capacity	\$24.95
HMT202XL	2" drop, 12 1/2" long	7,500 lb capacity	\$36.95

### 4" Drop Tubular Ball Mounts

HMT204	4" drop, 8 3/8" long	7,500 lb capacity	\$25.95
HMT204L	4" drop, 10 3/8" long	7,500 lb capacity	\$28.95
HMT204XL	4" drop, 12 3/8" long	7,500 lb capacity	\$41.95

### 6" Drop Tubular Ball Mounts

HMT206	6" drop, 9 3/8" long	7,500 drop, 6,000 rise	\$34.95
HMT206L	6" drop, 11 3/8" long	7,500 drop, 6,000 rise	\$39.95
HMT206XL	6" drop, 14 1/2" long	7,500 drop, 6,000 rise	\$48.95

### 8-10" Drop Tubular Ball Mounts

HMT208	8" drop, 11 1/4" long	5,000 drop, 3,500 rise	\$45.95
HMT208L	8" drop, 13 1/4" long	5,000 drop, 3,500 rise	\$46.95
HMT210	10" drop, 12 3/4" long	5,000 drop, 3,500 rise	\$52.95
HMT210L	10" drop, 14" long	5,000 drop, 3,500 rise	\$69.95

## Calculating Ball Mount Drop Needed



**1.** Measure distance from ground to top of receiver tube opening.

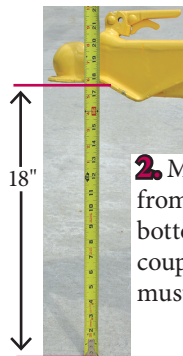

**2.** Measure distance from ground to bottom of trailer coupler. Trailer must be level.

**3.** Subtract trailer coupler height from receiver tube height to calculate amount of ball mount drop needed. (Opposite for rise) (Be sure to figure in the vehicle sag that will occur when trailer tongue weight is applied to vehicle)

## Loaded Ball Mounts



- Fits 2" standard receivers
- Includes factory torqued 2" trailer ball & 5/8" pin & clip

HMT272	2" drop, 7 3/8" length	7,500/750	\$42.95
HMT274	4" drop, 8 1/2" length	7,500/750	\$43.95

## Solid Steel Ball Mounts



- 1 1/4" ball hole
- Fits standard 2" receivers
- Uses 5/8" pin & clip (not included)
- Length is measured from pin hole to ball hole
- Black powder coated (except HMS208)

### 2" Drop Solid Steel Ball Mounts

HMS202	2" drop, 8 1/2" long	16,000 lb capacity	\$61.95
HMS202L	2" drop, 10 1/4" long	16,000 lb capacity	\$67.95

### 4" Drop Solid Steel Ball Mounts

HMS204	4" drop, 9 3/8" long	16,000 lb capacity	\$69.95
HMS204L	4" drop, 11 3/8" long	16,000 lb capacity	\$77.95

### 6" Drop Solid Steel Ball Mount

HMS206	6" drop, 10 3/4" long	16,000 lb capacity	\$82.95
--------	-----------------------	--------------------	---------

### 8" Drop Solid Steel Ball Mount

HMS208	8" drop, 10" long	12,000 lb capacity	\$88.95
--------	-------------------	--------------------	---------

## Forged Ball Mounts



- 1 1/4" ball hole
- Fits standard 2" receivers
- Uses 5/8" pin & clip (not included)
- Length is measured from pin hole to ball hole

HMS902	2" drop, 7 3/8" long	20,000/2,000 lb capacity	\$39.95
HMS922	2" drop, 8 1/2" long	17,000/2,550 lb capacity	\$79.95
HMS904	4" drop, 7 3/8" long	20,000/2,000 lb capacity	\$49.95
HMS924	4" drop, 8 1/2" long	17,000/2,550 lb capacity	\$88.95
HMS906	6" drop, 9 3/8" long	17,000/1,700 lb capacity	\$61.95
HMS926	6" drop, 9 1/2" long	17,000/2,550 lb capacity	\$101.95

# 2" Ball Mounts



## Polished Aluminum Ball Mounts



HMSA202

- 1¼" ball hole
  - Fits 2" standard receivers
  - Uses 5/8" pin & clip (not included)
  - Aircraft-grade high-strength billet aluminum
  - Machined from one solid piece. No welds or seams
  - See page 14 for Stainless Steel hitch balls with 1¼" shank
- |         |                   |                          |         |
|---------|-------------------|--------------------------|---------|
| HMSA202 | 2" drop, 8" long  | 14,000/2,000 lb capacity | \$79.95 |
| HMSA204 | 4" drop, 8½" long | 14,000/2,000 lb capacity | \$84.95 |

## Forged Aluminum Ball Mount



- 1" ball hole
  - Fits 2" standard receivers
  - Uses 5/8" pin & clip (not included)
  - Solid aluminum shank
  - See page 14 for Stainless Steel hitch balls with 1" shank
- |         |                                      |         |
|---------|--------------------------------------|---------|
| HMSA201 | 2" drop, 8½" long, 8,000 lb capacity | \$65.95 |
|---------|--------------------------------------|---------|

## Triple Tow Ball Mounts



16,000 lb!

- 1⅞", 2", and 2⅝" hitch balls
- Fits 2" standard receivers
- Uses 5/8" pin & clip (not included).
- HMT20TL has a tubular shank
- HMS20T0 has chrome balls and a 7,500 lb cast steel pintle jaw
- HMS20TP has a cushioned draw bar to give you smoother towing

ITEM#	Ball Type	2⅝"	2"	1⅞"	Price
HMT20TL	Black	10,000	7,500	5,000	\$68.95
HMS20TL	Black	10,000	7,500	5,000	\$85.95
HMS20TH	Black	16,000	10,000	2,000	\$96.95
HMS20TC	Chrome	10,000	7,500	5,000	\$89.95
HMS20T0	Pintle	10,000	7,500	6,000	\$127.95
HMS20TP	Cushion	10,000	10,000	2,000	\$139.95

## 10K Tubular Ball Mounts

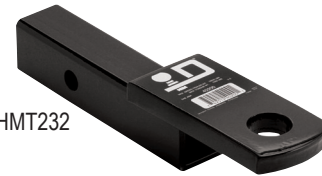

HMT232

- 1¼" ball hole
  - Fits 2" standard receivers
  - Uses 5/8" pin & clip (not included)
- |        |                   |                                |         |
|--------|-------------------|--------------------------------|---------|
| HMT232 | 2" drop, 8½" long | 10,000 lb capacity             | \$41.95 |
| HMT234 | 4" drop, 9" long  | 10,000 lb capacity             | \$53.95 |
| HMT236 | 6" drop, 9" long  | 10,000 lb capacity (drop only) | \$58.95 |

## Cushioned Ball Mounts



Cut-away View of HCM2

HCM2

- Internal polypropylene cushions act as shock absorbers
  - Fits 2" standard receivers
  - Uses 5/8" pin & clip. (Not included)
  - 2,000 lb tongue weight
- |       |         |               |           |          |
|-------|---------|---------------|-----------|----------|
| HCM2  | 2" drop | 1" ball hole  | 10,000 lb | \$72.95  |
| HCM4  | 4" drop | 1" ball hole  | 10,000 lb | \$79.95  |
| HCM6  | 6" drop | 1" ball hole  | 10,000 lb | \$83.95  |
| HCMH2 | 2" drop | 1¼" ball hole | 14,000 lb | \$105.95 |

## Double Tow Ball Mounts



HMTD201

HMSD201

HMSD202

New!

- Fits 2" standard receivers
  - Uses 5/8" pin & clip (not included)
- |         |   |         |
|---------|---|---------|
| HMTD201 | 2" ball on top, 2⅝" ball on bottom (6,000 lb) | \$51.95 |
| HMSD201 | 2"(7,500 lb) & 2⅝"(10,000) ball, solid shank  | \$76.95 |
| HMSD202 | 2"(10,000 lb) & 2⅝"(16,000) ball, solid shank | \$67.95 |



# 2" Adjustable Ball Mounts

## Pin Style Aluminum Ball Mounts



- Fits 2" standard receivers
- Polished aluminum
- Stunning good looks
- Lightning quick adjustment
- 2" ball: 8,000 GTW, 1,000 TW
- 2½" ball: 10,000 GTW, 1,000 TW

HMSA704	4" drop	\$240.00
HMSA706	6" drop	\$240.00
HMSA708	8" drop	\$250.00
HMSA710	10" drop	\$250.00
HMSA700	Keyed-Alike Locking Pin Set	\$51.95

## Integrated Scale Aluminum Ball Mounts



- Fits 2" standard receivers
- Polished aluminum
- Stunning good looks
- Lightning quick adjustment
- Built-in mechanical tongue weight scale!
- Proper tongue weight gives better steering, braking, & reduced sway
- 2" ball: 8,000 GTW, 800 TW
- 2½" ball: 10,000 GTW, 1,000 TW

HMSA804	4" drop	\$340.00
HMSA806	6" drop	\$340.00
HMSA808	8" drop	\$350.00
HMSA809	10" drop	\$350.00
HMSA700	Keyed-Alike Locking Pin Set	\$51.95

## Locking Aluminum Ball Mount



- Fits 2" standard receivers
- Polished aluminum
- 2" & 2½" balls
- Built-in anti-rattle
- Built-in receiver lock with keys
- 10,000/7,500 GTW, 1,500 TW

HMSA406	6" drop	\$280.00
---------	---------	----------

## FLASH Steel Ball Mounts



- Fits 2" standard receivers
- Glossy black powder coated
- 2" and 2½" balls
- No tools needed to adjust height
- Solid forged steel construction

HMSD706	6" drop	12,000/8,000 GTW	1,200 TW	\$270.95
HMSD710	10" drop	12,000/8,000 GTW	1,200 TW	\$250.00
HMSD700	Keyed-Alike Locking Pin Set			\$51.95

## Tow & Stow

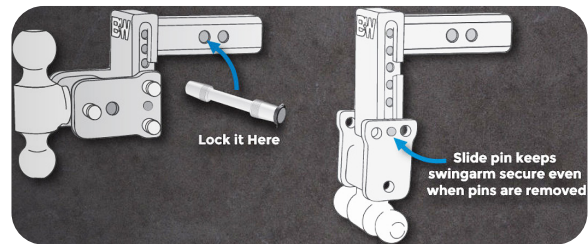
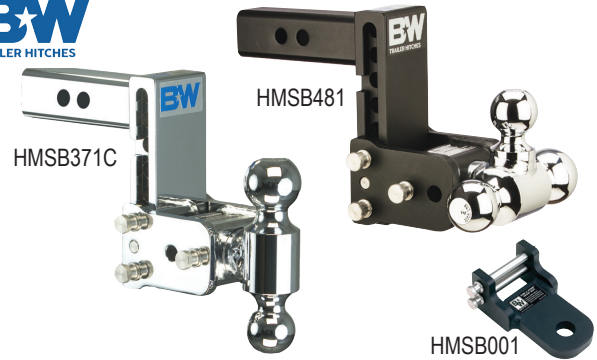

- Stows under vehicle when not in use
- Ball Ratings: 1½" (3500 lb), 2" (7500 lb) & 2½" (10,000 lb)
- HMSB001 - not intended to be used as a ball mount

ITEM#	MFG#	Color	Drop	Ball Sizes	Price
HMSB331	TS10033B	Black	3"	2", 2½"	\$239.95
HMSB471	TS10047B	Black	3"	1½", 2", 2½"	\$249.00
HMSB371	TS10037B	Black	5"	2", 2½"	\$269.95
HMSB481	TS10048B	Black	5"	1½", 2", 2½"	\$279.00
HMSB401	TS10040B	Black	7"	2", 2½"	\$299.00
HMSB491	TS10049B	Black	7"	1½", 2", 2½"	\$309.00
HMSB431	TS10043B	Black	9"	2", 2½"	\$349.00
HMSB371C	TS10037C	Chrome	5"	2", 2½"	\$329.00
HMSB481C	TS10048C	Chrome	5"	1½", 2", 2½"	\$339.00
HMSB001	TS35100B	Draw bar Attachment for 2" Tow & Stow			\$74.95
HMSB101	TS35010	Replacement Pin & Clip for Tow & Stow			\$12.95

# 2" Adjustable Ball Mounts



## GEN-Y REBEL Ball Mounts



*New!*

- Fits 2" standard receivers
- Uses 5/8" pin and clip (not included)
- Ball plate has 1" ball hole
- No tools to adjust height
- Light weight, tough, durable
- 100% Satisfaction Guaranteed!

HMSG013	5,000 GTW	500 TW	4.5" drop	\$97.95
HMSG014	5,000 GTW	500 TW	7" drop	\$108.95

## GEN-Y REBEL X Ball Mounts



*New!*

- Fits 2" standard receivers
- Uses 5/8" pin and clip (not included)
- Ball plate has 1" ball hole
- No tools to adjust height
- Light weight, tough, durable
- 100% Satisfaction Guaranteed!

HMSG053X	7,000 GTW	700 TW	4.5" drop	\$144.95
HMSG054X	7,000 GTW	700 TW	7" drop	\$154.95

## GEN-Y Glyder Torsion Ball Mounts



HMSG12001

HMSG12005

- 1" ball hole
- Fits 2" standard receivers
- Precision milled & drilled
- Heavy duty rubber torsion-flex cords
- 100% Satisfaction Guaranteed!
- 5-year torsion warranty; Lifetime workmanship warranty!

HMSG12001	7,000 GTW	400-700 TW	2" drop	\$199.95
HMSG12005	7,000 GTW	400-700 TW	6" drop	\$299.95

## GEN-Y Mega-Duty Ball Mounts



HMSG524

- Fits 2" standard receivers
- No tools to adjust height
- Super heavy duty construction
- 2" and 2 5/16" balls, and pintle all in 1 unit
- 100% Satisfaction Guaranteed!

HMSG324	10,000/10,000 GTW	1,500 TW	7.5" drop	\$287.95
HMSG523	16,000/10,000 GTW	2,000 TW	5" drop	\$307.95
HMSG524	16,000/10,000 GTW	2,000 TW	7.5" drop	\$318.95
HMSG525	16,000/10,000 GTW	2,000 TW	10" drop	\$339.95
HMSG090	1 1/8" add-on ball for Gen-Y ball mounts			\$21.95
HMSG032	2" Replacement Pintle Lock			\$48.95
HMSG099	5/8" replacement pin, 4 1/8" usable length			\$12.95

## GEN-Y Boss Torsion Ball Mounts



HMSG1225

- Fits 2" standard receivers
- No tools to adjust height
- Super heavy duty construction
- Heavy duty rubber torsion-flex cords
- Choose model according to TW for optimum performance
- Built-in mechanical tongue weight scale
- 2" and 2 5/16" balls, and pintle all in 1 unit
- 2" ball is rated to 10,000 GTW
- 100% Satisfaction Guaranteed!
- 5-year torsion warranty; Lifetime workmanship warranty!

HMSG1024	10,000 GTW	500-1,100 TW	5" drop	\$644.95
HMSG1225	16,000 GTW	800-1,700 TW	7.5" drop	\$720.95
HMSG090	1 1/8" add-on ball for Gen-Y ball mounts			\$21.95
HMSG032	2" Replacement Pintle Lock			\$48.95
HMSG099	5/8" replacement pin, 4 1/8" usable length			\$12.95

## Adjustable Ball Mounts



- Fits standard 2" receiver
- Includes 5/8" receiver pin and clip
- 2 pin holes give the option of 10 1/4" or 11 1/4" length

<b>HMSD205</b>	6" drop, 2" & 2 5/16" balls & shank, 14,000	\$219.95
<b>HMSD206</b>	10" drop, 2" & 2 5/16" balls & shank, 14,000	\$430.95
<b>HMSD209</b>	6" drop, 2 5/16" duplex pintle & shank, 13,000	\$313.95
<b>HMSD217</b>	2" Duplex Pintle only, 10,000 lb capacity	\$176.95
<b>HMSD216</b>	2 5/16" Duplex Pintle only, 13,000 lb capacity	\$181.95
<b>HMSD218</b>	Adjustable Shank only, 14,000 lb capacity	\$139.95
<b>HMSD213</b>	Locking Pin Set (receiver and channel)	\$97.95
<b>HMSD312</b>	Replacement pair of pins	\$26.95

## Adjustable Triple Tow Ball Mount

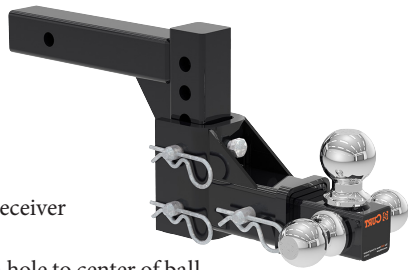

- Fits standard 2" receiver
- 5 3/4" drop
- 16" long from pin hole to center of ball

<b>HMS20TA</b>	Adjustable triple tow, 10,000/7,500/6,000	\$226.95
----------------	---	----------

## Rebellion Adjustable Ball Mount



- Fits 2" receiver
- Cushioned with heavy duty ShockDrop™ technology
- Dampens jerking and jarring for smoother tow
- 6" drop, shank cannot be used upside down

<b>HMSD230</b>	6" drop, 2" & 2 5/16" balls & shank, 15,000	\$449.95
----------------	---	----------

## Adjustable Ball Mounts



- Fits standard 2" receivers
- Uses 5/8" pin and clip (not included)
- 11" drop with ball plate down, and in lowest hole
- Adjustable ball mounts can be used in rise position
- Ball plate attaches with two 5/8" pins for easy adjustment
- Tongue weight rating is 10% of capacity

<b>HMT20A</b>	1" ball hole, 13" length, 6,000 lb capacity	\$59.95
<b>HMS210A</b>	1" ball hole, 12 3/4" length, 10,000 lb capacity	\$116.95
<b>HMT20B</b>	Extra ball plate for HMT20A	\$35.95

## Adjustable/Convertible Ball Mounts



- **HPH1**: Stainless steel 3-ball combination & pintle sleeve; 10,000GTW/2,000TW with interchangeable balls; 25,000GTW/5,000TW with pintle sleeve; mounting hardware included.

<b>HW030</b>	Cushioned shank bar, 10,000/2,000	\$136.95
<b>HWB300</b>	Shank bar (more shank bars on page 125)	\$109.95
<b>HW032</b>	Ball mount adapter, 1" ball hole, 10,000/2,000	\$39.95
<b>HW034</b>	Clevis pin adapter, 1" ball/pin hole, 10,000/2,000	\$53.95
<b>HW036</b>	Pintle 4-bolt adapter plate, 10,000/2,000	\$44.95
<b>HW039</b>	Pair of 3/4" pins & clips for HW032/34/36	\$11.95
<b>HPH1</b>	Pintle convert-a-ball combo	\$289.95
<b>HPDSC</b>	8 ton hook, 8 ton ball rating, 2 5/16" ball	\$119.95
<b>HPM812</b>	Pintle mounting plate, 16,000 lb	\$104.95

# Miscellaneous Ball Mounts



## GEN-Y Mega-Duty Shanks



HMSG503

- Fits 2" standard receivers
- Super heavy duty construction
- Use with your standard 2" ball mount, bike rack, cargo rack, etc.
- 2 pins included
- 100% Satisfaction Guaranteed!

HMSG503	5" drop	16,000 GTW	2,000 TW	\$201.95
HMSG504	7½" drop	16,000 GTW	2,000 TW	\$212.95
HMSG505	10" drop	16,000 GTW	2,000 TW	\$233.95
HMSG099	⅝" replacement pin, 4⅛" usable length			\$12.95

## GEN-Y Bolt-On Adjustable Hitch



- Bolt or weld to your truck
- No tools to adjust
- Super heavy duty construction
- 2" and 2⅝" balls, and pintle all in 1 unit
- 2 pins included
- 100% Satisfaction Guaranteed!

HMSG124	16,000/10,000 GTW, 2,000 TW	7½" drop	\$339.95
HMSG032	2" Replacement Pintle Lock		\$48.95
HMSG099	⅝" replacement pin, 4⅛" usable length		\$12.95

## Receiver Tow Hooks



HATH5



HATH12



HATH326



HATH327

- Fits 2" receiver unless noted otherwise
- Do not exceed receiver hitch capacity

HATH5	Tow hook, WLL maximum hitch capacity	\$58.95
HATH12	Forged receiver tow eye, 10,000 WLL	\$39.95
HATH326	2" receiver ¾" shackle, 9,500 WLL	\$49.95
HATH327	*2½" receiver* ¾" shackle, 13,000 WLL	\$76.95

## ATV Ball mount



HMATVS4	Fits 2" ATV receiver, has 2" ball	\$48.95
---------	-----------------------------------	---------

## Clevis Mounts

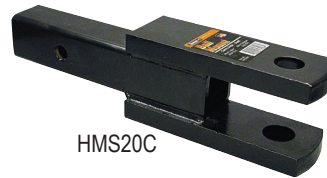

HMS20C



HCMCC

- 1" clevis holes
- Fits standard 2" receiver
- Use ⅝" receiver pin & clip (not included)

HMS20C	Solid Steel, 8,000 GTW	\$49.95
HCMCC	Cushioned, 10,000 GTW	\$87.95
HARPP1	1" Clevis tongue pin, poly-coated handle	\$9.99

## Class 1 & 2 Ball Mounts



HMS122



HMS124



HMS125

- Fits standard 1¼" receiver
- ¾" ball hole
- Uses ½" pin & clip (not included)
- 3,500 lb Gross Trailer Weight
- Length is measured from pin hole to ball hole

HMS122	1¼" drop	7" long	\$29.95
HMS122L	1¼" drop	9¾" long	\$43.95
HMS124	3½" drop	7¼" long	\$42.95
HMS124L	4" drop	10" long	\$32.95
HMS125	5" rise only	10" long	\$43.95
HMS126	6¾" drop	7¼" long	\$51.95



# 2 1/2" Ball Mounts

## 2 1/2" Ball Mounts



HMT254

- Fits 2 1/2" receiver
- 1 1/4" ball hole
- Uses 5/8" pin & clip. (not included)
- Length is measured from pin hole to ball hole

HMT252	2" drop	8 1/2" long	16,000GTW, 1,600TW	\$68.95
HMT254	4" drop	9 5/8" long	16,000GTW, 1,600TW	\$72.95
HMT256	6" drop	10 3/4" long	16,000GTW, 1,600TW	\$88.95
HMT258	7 3/4" drop	10" long	15,000GTW, 1,500TW	\$65.95

## 2 1/2" Cushioned Ball Mounts



Cut-away View



HCMV252

- Fits 2 1/2" receiver
- 1 1/4" ball hole
- Uses 5/8" pin & clip. (not included)
- Enclosed polypropylene cushions act as shock absorbers and reduce bouncing and jerking, giving you and your pickup a smoother ride.

HCMV252	2" drop	9" long	18,000GTW/2,000 TW	\$115.95
HCMV254	4" drop	9 1/2" long	18,000GTW/2,000 TW	\$124.95
HCMV256	6" drop	10" long	18,000GTW/2,000 TW	\$129.95

## 2 1/2" Forged Ball Mounts



HMS954

- Fits 2 1/2" receiver
- 1 1/4" ball hole
- Uses 5/8" pin & clip. (not included)
- Length is measured from pin hole to ball hole

HMS952	2" drop	8 1/2" long	20,000GTW, 2,700TW	\$102.95
HMS954	4" drop	8 1/2" long	20,000GTW, 2,700TW	\$116.95
HMS956	6" drop	9" long	20,000GTW, 2,700TW	\$150.95
HMS958	8" drop	10" long	20,000GTW, 2,700TW	\$177.95

## 2 1/2" Triple Tow Ball Mounts



HMS25TP

HMT25TL

- Fits 2 1/2" receiver
- Uses 5/8" pin & clip (not included).
- HMS25TP: cushioned draw bar to give you smoother towing
- HMT25TL: 7 1/2" shank for 1 7/8" ball, 8 3/4" shank for 2" and 2 5/16" ball
- Does not fit all Ford OEM hitches

ITEM#	Ball Type	2 5/8"	2"	1 7/8"	Price
HMT25TL	Black	14,000	10,000	2,000	\$83.95
HMS25TP	Cushion	10,000	10,000	2,000	\$177.95



Trailer Tongue Tool Boxes  
See page 43

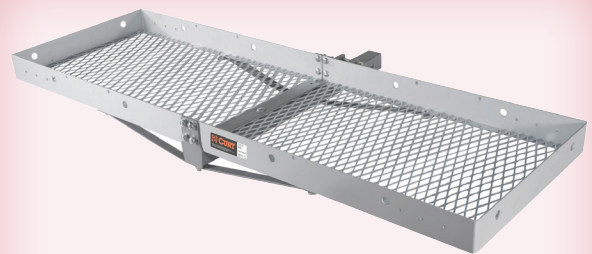

Folding Aluminum Cargo Carrier  
See page 21

# 2 1/2" Adjustable Ball Mounts



## 2 1/2" Pin Style Aluminum Ball Mounts



HMSA756



HMSA750

**18,000 lbs.**

- Fits 2 1/2" receiver
- Polished aluminum
- Stunning good looks
- Lightning quick adjustment
- 2" ball: 12,000 GTW, 1,200 TW
- 2 5/16" ball: 18,000 GTW, 1,800 TW

HMSA756	6" drop	\$270.00
HMSA758	8" drop	\$280.00
HMSA759	10" drop	\$280.00
HMSA750	Keyed-Alike Locking Pin Set	\$58.95

## 2 1/2" Tow & Stow



HMSB372

- Fits 2 1/2" receiver
- Stows under vehicle when not in use
- Ball Ratings: 1 7/8" (3,500 lb), 2" (7,500 lb) & 2 5/16" (14,500 lb)

ITEM#	MFG#	Color	Drop	Ball Sizes	Price
HMSB372	TS20037B	Black	5"	2", 2 5/16"	\$309.00
HMSB482	TS20048B	Black	5"	1 7/8", 2", 2 5/16"	\$319.00
HMSB402	TS20040B	Black	7"	2", 2 5/16"	\$349.00
HMSB492	TS20049B	Black	7"	1 7/8", 2", 2 5/16"	\$359.00
HMSB432	TS20043B	Black	9"	2", 2 5/16"	\$389.00
HMSB002	TS35200B	Draw bar Attachment for 2 1/2" Tow & Stow			\$86.95

## 2 1/2" Locking Aluminum Ball Mounts



HMSA506

- Fits 2 1/2" receiver
- Polished Aluminum
- Built-in Anti-rattle
- Built-in receiver lock with keys
- Stores under vehicle when not in use
- 2" & 2 5/16" balls
- 10,000/7,500 GTW, 1,500 TW

HMSA506	6" drop	\$310.00
---------	---------	----------

## 2 1/2" MultiPro Tow & Stow



HMSB404

- Fits 2 1/2" receiver
- Stows under vehicle when not in use
- Ball Ratings: 2" (7,500 lb) & 2 5/16" (14,500 lb)
- Specially designed for use with GMC/Chevy MultiPro tailgate

ITEM#	MFG#	Color	Drop	Ball Sizes	Price
HMSB404	TS20066BMP	Black	7"	2", 2 5/16"	\$389.00

## 2 1/2" FLASH Steel Ball Mounts



HMSD756



HMSD750

- Fits 2 1/2" receiver
- No tools needed to adjust height
- Solid forged steel construction
- Glossy black powder coated
- 2" and 2 5/16" balls

HMSD756	20,000/12,000 GTW	2,000 TW	6" drop	\$270.00
HMSD759	20,000/12,000 GTW	2,000 TW	10" drop	\$280.00
HMSD750	Locking pin set for receiver and ball adjustment			\$58.95

## 2 1/2" Adjustable Ball Mount



American Made!

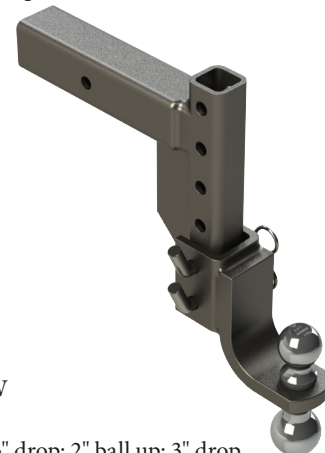

- Fits 2 1/2" receiver
- 2 5/16" ball 20,000 GTW
- 2" ball 10,000 GTW
- With 2 5/16" ball up: 7 1/2" drop; 2" ball up: 3" drop

HMS220A	2 1/2" Adjustable Ball mount	\$211.95
---------	------------------------------	----------





# 2 1/2" Adjustable Ball Mounts

## 2 1/2" GEN-Y Mega-Duty Ball Mounts



HMSG623

- Fits 2 1/2" receiver
- No tools to adjust
- Super heavy duty construction
- 2" and 2 5/16" balls, and pintle all in 1 unit
- 100% Satisfaction Guaranteed!

HMSG623	6" drop	21,000/10,000 GTW	3,000 TW	\$414.95
HMSG624	9" drop	21,000/10,000 GTW	3,000 TW	\$424.95
HMSG090	1 7/8" add-on ball for Gen-Y ball mount			\$21.95
HMSG062	2 1/2" Replacement Pintle Lock			\$60.95
HMSG099	5/8" replacement pin, 4 1/8" usable length			\$12.95

## 2 1/2" GEN-Y Boss Torsion Ball Mounts



HMSG1125

- Fits 2 1/2" standard receivers
- No tools to adjust height
- Super heavy duty construction
- Heavy duty rubber torsion-flex cords
- Choose a model to match your TW for optimum performance
- Built-in mechanical tongue weight scale
- 2" and 2 5/16" balls, and pintle all in 1 unit
- 2" ball is rated to 10,000 GTW
- 100% Satisfaction Guaranteed!
- 5-year torsion warranty; Lifetime workmanship warranty!

HMSG1124	5" drop	16,000 GTW	1,000-1,700 TW	\$753.95
HMSG1125	7 1/2" drop	16,000 GTW	1,000-1,700 TW	\$775.95
HMSG1324	6" drop	21,000 GTW	1,500-2,400 TW	\$873.95
HMSG1325	9" drop	21,000 GTW	1,500-2,400 TW	\$906.95
HMSG090	1 7/8" add-on ball for Gen-Y ball mounts			\$21.95
HMSG062	2 1/2" Replacement Pintle Lock			\$60.95
HMSG099	5/8" replacement pin, 4 1/8" usable length			\$12.95

## 2 1/2" Adjustable Ball Mount



HMSD305

HMSD309

- Fits 2 1/2" receiver
- Includes 5/8" receiver pin and clip
- 2 pin holes gives the option of 11" or 12" length

HMSD305	6" drop, 2" & 2 5/16" balls with shank, 20,000	\$339.95
HMSD306	10" drop, 2" & 2 5/16" balls with shank, 20,000	\$489.95
HMSD309	2 5/16" duplex pintle with adjustable shank, 20,000	\$414.95
HMSD316	2 5/16" duplex pintle only, 20,000 GTW	\$213.95
HMSD318	Shank only, 9 holes vertical adjustment	\$206.95
HMSD213	Locking Pin Set (receiver and channel)	\$97.95
HMSD312	Replacement pair of pins	\$26.95

## 2 1/2" Rebellion Adjustable Ball Mount



HMSD330

HMSD236

- Fits 2 1/2" receiver
- Cushioned with heavy duty ShockDrop™ technology
- 8" drop, 1" rise, shank cannot be used upside down
- HMSD236 has standard 3 3/8" by 1 3/4" bolt pattern, 4 bolts included

HMSD330	2" & 2 5/16" balls with adjustable shank, 20,000	\$649.95
HMSD236	Pintle mount plate for HMSD330	\$83.95



Receiver Reducer Adapters  
See page 16

# 3" Ball Mounts



## 3" Adjustable Ball Mount



3"

- Fits 3" receiver
  - 10" drop
  - 2 pin holes gives the option of 11" or 12" length
- HMSD356** 2" & 2<sup>5</sup>/<sub>16</sub>" balls with adjustable shank, 21,000 **\$509.95**

## 3" Tow & Stow

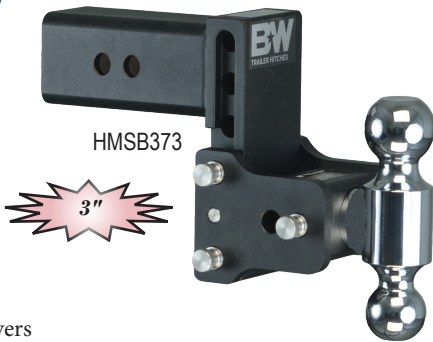

3"

- Fits 3" receivers
  - Stows under vehicle when not in use
  - Ball Ratings: 2" (7,500 lb) & 2<sup>5</sup>/<sub>16</sub>" (21,000 lb)
- | ITEM#          | MFG#     | Color                                | Drop | Ball Sizes                            | Price           |
|----------------|----------|--------------------------------------|------|---------------------------------------|-----------------|
| <b>HMSB373</b> | TS30037B | Black                                | 5"   | 2" & 2 <sup>5</sup> / <sub>16</sub> " | <b>\$349.00</b> |
| <b>HMSB403</b> | TS30040B | Black                                | 7"   | 2" & 2 <sup>5</sup> / <sub>16</sub> " | <b>\$379.00</b> |
| <b>HMSB003</b> | TS35300B | Drawbar attachment for 3" Tow & Stow |      |                                       | <b>\$98.95</b>  |

## 3" Ball Mounts



HMS934

3"

- Fits 3" receivers
  - 1<sup>1</sup>/<sub>4</sub>" ball hole
  - Uses long <sup>5</sup>/<sub>8</sub>" pin & clip HARPL (Not included)
- |               |         |                                       |                   |                 |
|---------------|---------|---------------------------------------|-------------------|-----------------|
| <b>HMS934</b> | 4" drop | 9" long                               | 21,000GTW/2,800TW | <b>\$130.95</b> |
| <b>HMS936</b> | 6" drop | 10" long                              | 21,000GTW/2,800TW | <b>\$139.95</b> |
| <b>HMS938</b> | 8" drop | 10 <sup>1</sup> / <sub>2</sub> " long | 21,000GTW/2,800TW | <b>\$147.95</b> |

## 3" GEN-Y Mega-Duty Ball Mounts



HMSG1724

3"

- Fits 3" receivers
  - No tools to adjust
  - Super heavy duty construction
  - 2" and 2<sup>5</sup>/<sub>16</sub>" balls, and pintle all in 1 unit
  - <sup>3</sup>/<sub>4</sub>" and <sup>5</sup>/<sub>8</sub>" receiver pin holes. Please order correct size pin
  - 100% Satisfaction Guaranteed!
- |                 |  |          |         |                 |
|-----------------|--|----------|---------|-----------------|
| <b>HMSG1723</b> | 32,000/10,000 GTW  | 3,500 TW | 6" drop | <b>\$480.95</b> |
| <b>HMSG1724</b> | 32,000/10,000 GTW  | 3,500 TW | 9" drop | <b>\$491.95</b> |
| <b>HMSG090</b>  | 1 <sup>7</sup> / <sub>8</sub> " add-on ball for Gen-Y ball mount                             |          |         | <b>\$21.95</b>  |
| <b>HMSG097</b>  | <sup>3</sup> / <sub>4</sub> " replacement pin, 4 <sup>1</sup> / <sub>8</sub> " usable length |          |         | <b>\$12.95</b>  |
| <b>HMSG099</b>  | <sup>5</sup> / <sub>8</sub> " replacement pin, 4 <sup>1</sup> / <sub>8</sub> " usable length |          |         | <b>\$12.95</b>  |

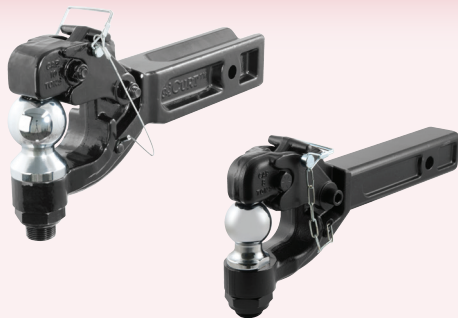

Duplex Pintle Ball Mounts  
See page 24



Don't miss the CURT BetterWeigh™  
See page 124



## Receiver Pins



- Secures ball mount in receiver hitch
- 5/8" pins are used on class 3, 4, & 5 receiver hitches
- 1/2" pins are used on class 1 & 2 receiver hitches
- HALP316 lynch does not fit HARP12

	5/8" pin & clip, 3" usable length for 2" receivers	\$3.99
<b>HARP</b>	Buy 6 or more, each	\$0.00
	Buy 12 or more, each	\$0.00
<b>HARPL</b>	5/8" pin & lynch, 5" usable length for up to 3" rec.	\$4.59
<b>HARP12</b>	1/2" pin & clip	\$2.49
<b>HALP316</b>	3/16" replacement lynch for HARP or HARPL	\$0.99
<b>HAHP1</b>	Replacement clip for HARP	\$1.85
<b>HAHP</b>	Replacement clip for HARP12	\$0.79

## Pivot Latch Receiver Pin



- Just pull out on the barrel head and rotate to latch in place
- Spring loaded barrel head locks on either side of the pin
- Class 3, 4, & 5 hitches

ITEM#	Description	Price
<b>HARP4</b>	Chrome 5/8" pivot pin	\$8.39
<b>HARP42</b>	Stainless Steel 5/8" pivot pin	\$17.95
<b>HARP45</b>	Stainless Steel 5/8" pivot pin for 2 1/2" receivers	\$20.95

## Lynch Pins



<b>HALP316</b>	3/16" lynch pin	\$0.99
<b>HALP516</b>	5/16" lynch pin	\$1.19
<b>HALP716</b>	7/16" lynch pin	\$1.99

## Trailer Tongue Scale



- Hydraulic pressure gauge for measuring trailer tongue weight
- Weighs 0-2,000 lb tongue weight

<b>HATTWS</b>	Load-Master Trailer Tongue Scale	\$169.95
---------------	----------------------------------	----------

## Locking Receiver Pins

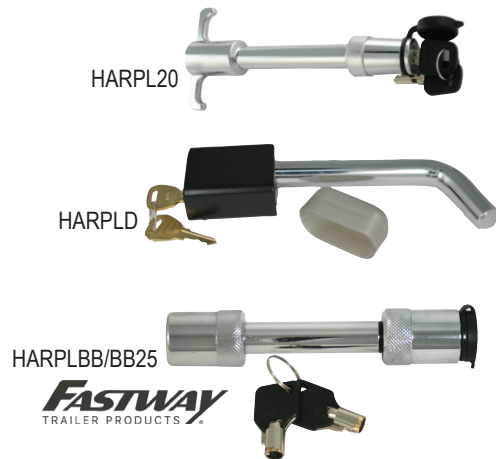

- Gives you peace of mind while parked or towing
- Includes key-hole cover

ITEM#	Size	Style	Fits	Price
<b>HARPL20</b>	5/8" for class 3	twin grip	2" receivers	\$7.99
<b>HARPLD</b>	5/8" for class 3-5	bent pin	2"-2 1/2" receivers	\$14.95
<b>HARPLBB</b>	5/8" for class 3-5	barbell	2" receivers	\$22.95
<b>HARPLBB25</b>	5/8" for class 3-5	barbell	2"-2 1/2" receivers	\$20.95
<b>HARPLBB30</b>	5/8" or 3/4" cls 3-5	barbell	2 1/2" -3" receivers	\$25.95
<b>HARPLM</b>	1/2" for class 1-2	bent pin	1 1/4" receivers	\$14.95

## Stainless Steel Locking Pins

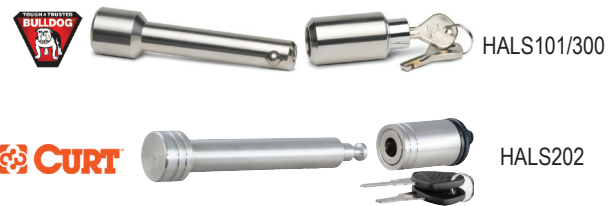

- Solid stainless steel
- HALS101/300 limited lifetime warranty
- HALS202 1 year warranty (3 9/16" usable length)

ITEM#	Size	Style	Fits	Price
<b>HALS101</b>	1/2" for class 1-2	barbell	1 1/4" receivers	\$29.95
<b>HALS300</b>	5/8" for class 3-5	barbell	2" receivers	\$30.95
<b>HALS202</b>	5/8" for class 3-5	barbell	2" & 2 1/2" receivers	\$53.95

## Poly-coated Pins



ITEM#		Poly-coated	Usable Length	Price
<b>HARPP</b>	5/8" pin & clip	Yes	4"	\$6.19
<b>HARPP3</b>	3/4" pin & clip	Yes	4 1/2"	\$7.29
<b>HARPP7</b>	7/8" pin & clip	Yes	4 1/2"	\$8.19
<b>HARPP117</b>	7/8" pin & clip	No	6 1/4"	\$5.99
<b>HARPP1</b>	1" pin & clip	Yes	4 1/2"	\$9.99
<b>HARPP118</b>	1 1/8" pin & clip	No	6 1/4"	\$9.19